





Grayhill, Inc.

62S11-H0-020C

Artikelnummer:	62S11-H0-020C
Tillverkare / Brand:	Grayhill, Inc.
Produktbeskrivning	ROTARY ENCODER OPTICAL 32PPR
Datablad:	 62S11-H0-020C.pdf
RoHS status	 Blyfri / Överensstämmer med RoHS
Lager skick	2219 pcs stock
Skicka från	Hong Kong
Leveransväg	DHL/Fedex/TNT/UPS/EMS

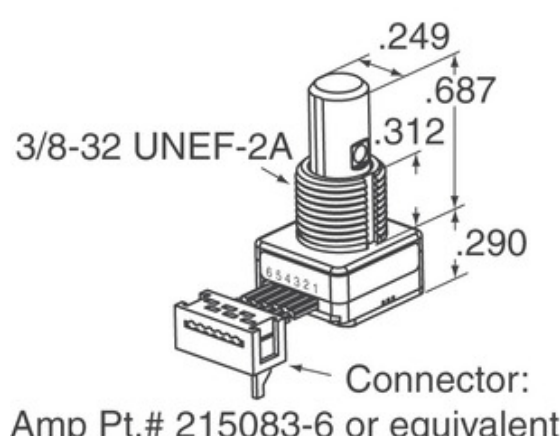
OFFERTFÖRFRÅGAN

Bilden kan vara representation. Se specifikationer för produktinformation.







Specifikationer för 62S11-H0-020C

ARTIKELNUMMER	62S11-H0-020C
TILLVERKARE	Grayhill, Inc.
BESKRIVNING	ROTARY ENCODER OPTICAL 32PPR
LEDNINGSFRI STATUS / ROHS-STATUS	Blyfri / Överensstämmer med RoHS
TILLGÄNGLIG KVANTITET	2219 pcs
DATABLAD	 62S11-H0-020C.pdf
SPÄNNING - TILLFÖRSEL	5V
AVSLUTNINGSTIL	Cable with Connector
SERIER	62S
ROTATIONSLIVSLÄNGD (CYKLAR MIN)	1M
PULSER PER REVOLUTION	32
UTMATNINGSTYP	Quadrature (Incremental)
ANDRA NAMN	62S11H0020C
ORIENTERING	Vertical
MONTERINGSTYP	Panel Mount
FUKTKÄNSLIGHETSNIVÅ (MSL)	1 (Unlimited)
LEDNINGSFRI STATUS / ROHS-STATUS	Lead free / RoHS Compliant
KODARE TYP	Optical
SPÄRR~~POS=TRUNC	Yes
INBYGGD SWITCH	No
AKTUATOR TYP	1/4" Dia Flatted End

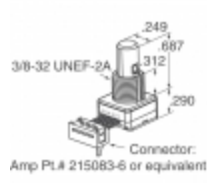
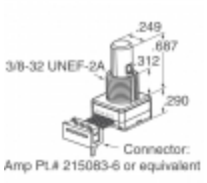
Relaterade etiketter

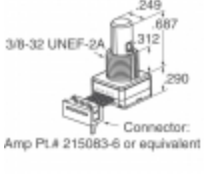
Grayhill, Inc. 62S11-H0-020C	62S11-H0-020C-distributör	62S11-H0-020C Leverantör
62S11-H0-020C pris	62S11-H0-020C Bilder	62S11-H0-020C-bild
62S11-H0-020C PDF Datablad	62S11-H0-020C Ladda ner datablad	62S11-H0-020C datablad
62S11-H0-020C-lager	Köp 62S11-H0-020C	Köp Grayhill, Inc. 62S11-H0-020C
Grayhill, Inc. 62S11-H0-020C	Grayhill, Inc. Leverantör	Grayhill, Inc.-distributör
Grayhill, Inc. 62S11-H0-020C	Grayhill Inc. 62S11-H0-020C	

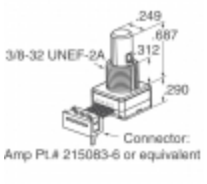
Relaterade produkter

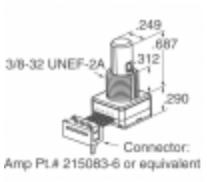
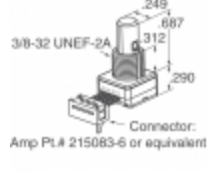
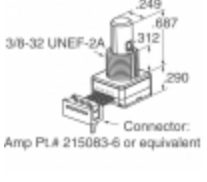
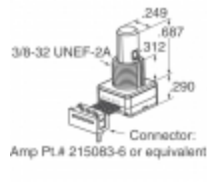
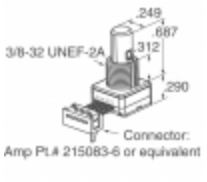
 <p>62S11-H9-025S tillverkare: Grayhill, Inc. Beskrivning: ROTARY ENCODER OPTICAL 32PPR I lager: 2155 pcs</p> <p>RFQ</p>	 <p>62S11-H0-020S tillverkare: Grayhill, Inc. Beskrivning: ROTARY ENCODER OPTICAL 32PPR I lager: 1990 pcs</p> <p>RFQ</p>
 <p>62S11-H0-040C tillverkare: Grayhill, Inc. Beskrivning: ROTARY ENCODER OPT 32PPR 2" CBL I lager: 2505 pcs</p> <p>RFQ</p>	 <p>62S11-H0-060SH tillverkare: Grayhill, Inc. Beskrivning: ROTARY ENCODER OPTICAL 32PPR I lager: 2339 pcs</p> <p>RFQ</p>
 <p>62S11-H0-030C tillverkare: Grayhill, Inc. Beskrivning: ROTARY ENCODER OPT 32PPR 2" CBL I lager: 2314 pcs</p> <p>RFQ</p>	 <p>62S11-H0-060C tillverkare: Grayhill, Inc. Beskrivning: ROTARY ENCODER OPTICAL 32PPR I lager: 2181 pcs</p> <p>RFQ</p>
 <p>62S11-H0-P tillverkare: Grayhill, Inc. Beskrivning: ROTARY ENCODER OPT 32PPR 10" CBL I lager: 2508 pcs</p> <p>RFQ</p>	 <p>62S11-H0-PH tillverkare: Grayhill, Inc. Beskrivning: ROTARY ENCODER OPTICAL 32PPR I lager: 2006 pcs</p> <p>RFQ</p>
 <p>62S11-H9-020C tillverkare: Grayhill, Inc. Beskrivning: ROTARY ENCODER OPTICAL 32PPR I lager: 2176 pcs</p> <p>RFQ</p>	 <p>62S11-H9-020S tillverkare: Grayhill, Inc. Beskrivning: ROTARY ENCODER OPTICAL 32PPR I lager: 2170 pcs</p> <p>RFQ</p>
 <p>62S11-H0-200S tillverkare: Grayhill, Inc. Beskrivning: ROTARY ENCODER OPTICAL 32PPR I lager: 1933 pcs</p> <p>RFQ</p>	 <p>62S11-H9-040C tillverkare: Grayhill, Inc. Beskrivning: ROTARY ENCODER OPTICAL 32PPR I lager: 1975 pcs</p> <p>RFQ</p>

Copyright © 2020 Tillförlitlig distributör av elektroniska komponenter

E-post: Info@infinity-electronic.com

Adress: 17F, Gaylord Commercial Building, 114-118 Lockhart Road, Wan Chai, Hong Kong

