

Panasonic

Panasonic

HE1AN-P-DC9V-H18

Artikelnummer:	HE1AN-P-DC9V-H18
Tillverkare / Brand:	Panasonic
Produktbeskrivning	HE RELAYS 1 FORM A 9VDC
Datablad:	 HE1AN-P-DC9V-H18.pdf
RoHs status	 Blyfri / Överensstämmer med RoHS
Lager skick	4621 pcs stock
Skicka från	Hong Kong
Leveransväg	DHL/Fedex/TNT/UPS/EMS

OFFERTFÖRFRÅGAN

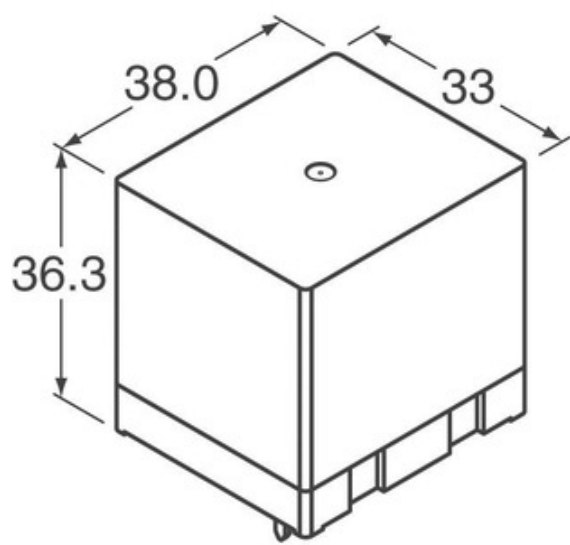

Bilden kan vara representation. Se specifikationer för produktinformation.











Specifikationer för HE1AN-P-DC9V-H18

ARTIKELNUMMER	HE1AN-P-DC9V-H18
TILLVERKARE	Panasonic
BESKRIVNING	HE RELAYS 1 FORM A 9VDC
LEDNINGSFRI STATUS / ROHS-STATUS	Blyfri / Överensstämmer med RoHS
TILLGÄNGLIG KVANTITET	4621 pcs
DATABLAD	 HE1AN-P-DC9V-H18.pdf
SERIER	*
FUKTKÄNSLIGHETSNIVÅ (MSL)	1 (Unlimited)
LEDNINGSFRI STATUS / ROHS-STATUS	Lead free / RoHS Compliant
DETALJERAD BESKRIVNING	Relay Coil

Relaterade etiketter

Panasonic HE1AN-P-DC9V-H18	HE1AN-P-DC9V-H18-distributör	HE1AN-P-DC9V-H18 Leverantör
HE1AN-P-DC9V-H18 pris	HE1AN-P-DC9V-H18 Bilder	HE1AN-P-DC9V-H18-bild
HE1AN-P-DC9V-H18 PDF Datablad	HE1AN-P-DC9V-H18 Ladda ner datablad	HE1AN-P-DC9V-H18 datablad
HE1AN-P-DC9V-H18-lager	Köp HE1AN-P-DC9V-H18	Köp Panasonic HE1AN-P-DC9V-H18
Panasonic HE1AN-P-DC9V-H18	Panasonic Leverantör	Panasonic-distributör
Panasonic HE1AN-P-DC9V-H18	Panasonic - Consumer Division HE1AN-P-DC9V-H18	Panasonic - Consumer Electronics Corp. HE1AN-P-DC9V-H18
Panasonic Battery Group HE1AN-P-DC9V-H18	Panasonic Electric Works - ACSD HE1AN-P-DC9V-H18	Panasonic Electronic Components - Semiconductor Pr HE1AN-P-DC9V-H18
Panasonic - ATG HE1AN-P-DC9V-H18	Panasonic - BSG HE1AN-P-DC9V-H18	Panasonic - DTG HE1AN-P-DC9V-H18
Panasonic Electric Works HE1AN-P-DC9V-H18	Panasonic Electronic Components HE1AN-P-DC9V-H18	Panasonic Industrial Automation Sales HE1AN-P-DC9V-H18
Panasonic Semiconductor HE1AN-P-DC9V-H18		

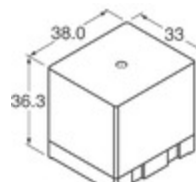
Relaterade produkter

 <p>HE1AN-Q-AC24V tillverkare: Panasonic Beskrivning: RELAY GEN PURPOSE SPST 30A 24V I lager: 3984 pcs</p> <p>RFQ</p>	 <p>HE1AN-Q-AC240V tillverkare: Panasonic Beskrivning: RELAY GEN PURPOSE SPST 30A 240V I lager: 4724 pcs</p> <p>RFQ</p>
 <p>HE1AN-Q-AC12V tillverkare: Panasonic Beskrivning: RELAY GEN PURPOSE SPST 30A 12V I lager: 3671 pcs</p> <p>RFQ</p>	 <p>HE1AN-P-DC24V tillverkare: Panasonic Beskrivning: RELAY GEN PURPOSE SPST 30A 24V I lager: 5103 pcs</p> <p>RFQ</p>
 <p>HE1AN-P-DC48V tillverkare: Panasonic Beskrivning: RELAY GEN PURPOSE SPST 30A 48V I lager: 4726 pcs</p> <p>RFQ</p>	 <p>HE1AN-P-DC12V-Y5 tillverkare: Panasonic Beskrivning: RELAY GEN PURPOSE SPST 48A 12V I lager: 2508 pcs</p> <p>RFQ</p>
 <p>HE1AN-P-DC6V-Y5 tillverkare: Panasonic Beskrivning: RELAY GEN PURPOSE SPST 48A 6V I lager: 2679 pcs</p> <p>RFQ</p>	 <p>HE1AN-P-DC9V-Y5 tillverkare: Panasonic Beskrivning: RELAY GEN PURPOSE SPST 48A 9V I lager: 2911 pcs</p> <p>RFQ</p>
 <p>HE1AN-Q-AC120V tillverkare: Panasonic Beskrivning: RELAY GEN PURPOSE SPST 30A 120V I lager: 4652 pcs</p> <p>RFQ</p>	 <p>HE1AN-P-DC9V-Y4 tillverkare: Panasonic Beskrivning: HE RELAYS 1 FORM A 9VDC I lager: 4805 pcs</p> <p>RFQ</p>
 <p>HE1AN-P-DC24V-Y5 tillverkare: Panasonic Beskrivning: RELAY GEN PURPOSE SPST 48A 24V I lager: 2622 pcs</p> <p>RFQ</p>	 <p>HE1AN-P-DC12V-H18 tillverkare: Panasonic Beskrivning: RELAY GEN PURPOSE SPST 35A 12V I lager: 6470 pcs</p> <p>RFQ</p>

Copyright © 2020 Tillförlitlig distributör av elektroniska komponenter

E-post: Info@infinity-electronic.com

Adress: 17F, Gaylord Commercial Building, 114-118 Lockhart Road, Wan Chai, Hong Kong

