

# SPECIFICATIONS



**Model Number:** MDD12B1E2X-E3  
**Part Number:** 17001162A

**Version:** 00  
**Jun. 12, 2018**

## Mechanical Drawing:

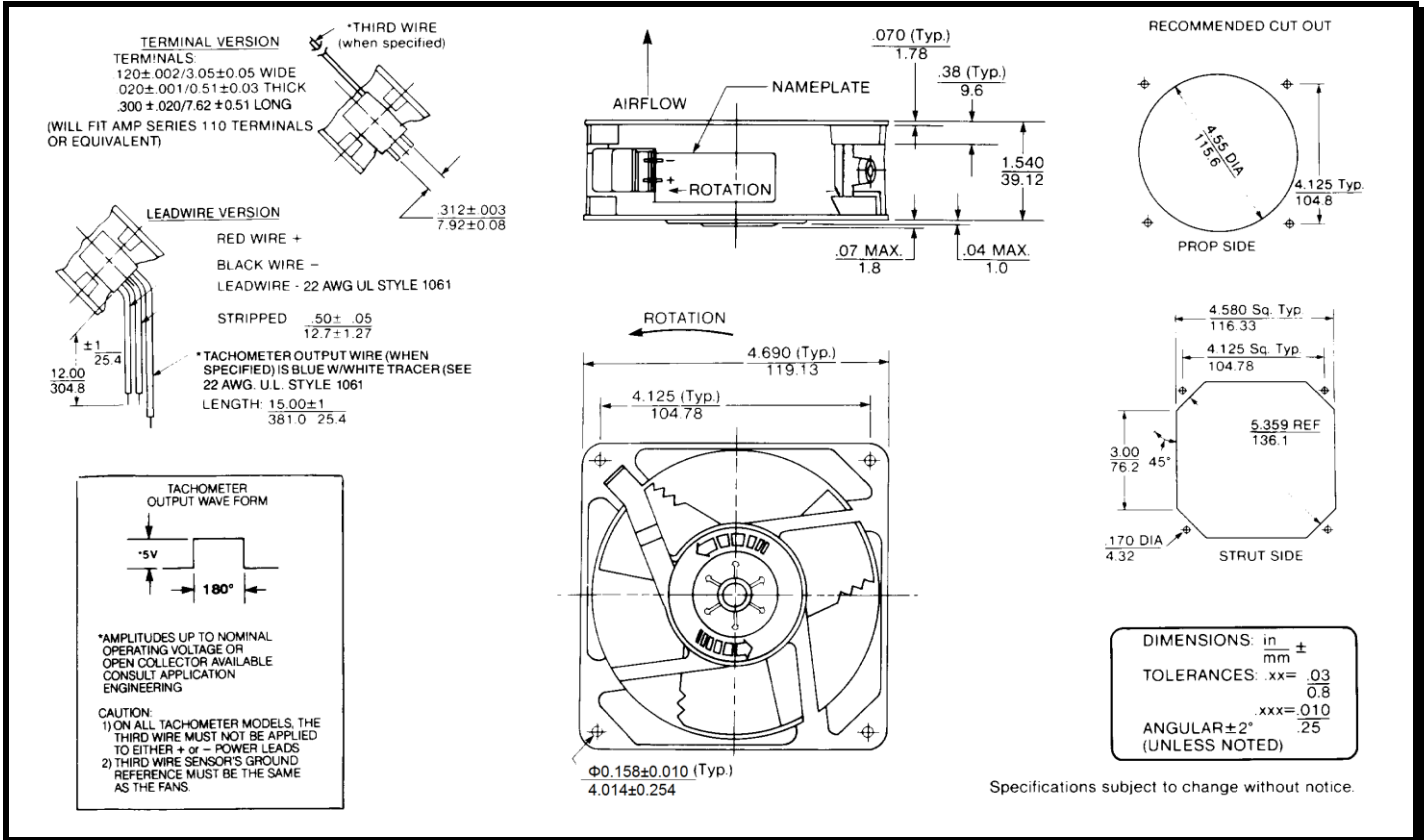

### Motor:

Nominal Voltage = 12 vdc  
 Operating Voltage Range = 8 - 16vdc  
 Nominal Running Current = 0.50 amps  
 Locked Rotor Current = 1.65 amps  
 Running Power = 6.0 watts  
 Average Speed = 3100 rpm  
 Bearings = Ball  
 Air Flow = 106 CFM  
 Acoustic = 50 dBA

### Construction:

Venturi: Die-Cast Aluminum, Black  
 Propeller: Plastic, Black, UL 94V-0

### Life Expectancy:

This fan is designed for continuous duty life of 55,000 hours at 70°C.

### Termination:

12"±1" (304.8±25.4mm) 22AWG UL1061 Leadwires  
 Red = Power(+)  
 Black = Return(-)  
 Blue/White = Tach output  
 Yellow = PWM control

### Additional Features:

Brushless DC Motor  
 Automatic Restart Capability  
 Electronic Locked Rotor Protection  
 Polarity Protected  
 Operating Temperature: -10°C to 70°C  
 Storage Temperature: -40°C to 85°C  
 Environmental Protection: Type 3(IP68)

### Tachometer:

Output: Open Collector  
 Ic: 20 mA max.  
 Vcc: 32 Vdc max.  
 Pulses per Revolution: 2  
 Isolated: No

### Speed Control:

PWM: 200 ~ 2 KHz, Open Collector  
 <10% Duty: Off  
 10%~95% Duty: Linear Ramp  
 >95% Duty or Open Lead Wire: Full Speed

### Agencies:

UL, CUL, CE

**PQ Curve:**

