

# NZF220TT1

## EMI Filter with ESD Protection

### Features:

- EMI/RFI Bi-directional “Pi” Low-Pass Filters
- ESD Protection Meets IEC61000-4-2
- Diode Capacitance: 7 – 10 pF
- Zener/Resistor Line Capacitance:  $22 \pm 20\%$  pF
- Low Zener Diode Leakage: 1  $\mu$ A Maximum
- Zener Breakdown Voltage; 6 – 8 Volts
- Pb-Free Package is Available

### Benefits:

- Designed to Suppress EMI/RFI Noise in Systems Subjected to Electromagnetic Interference
- Small Package Size Minimizes Parasitic Inductance, Thus a More “Ideal” Low Pass Filtering Response

### Applications:

- Cellular Phones
- Communication Systems
- Computers
- Portable Products with Input/Output Conductors

### MAXIMUM RATINGS

Rating	Symbol	Value	Unit
Peak Power Dissipation (Note 1) 8 × 20 $\mu$ s Pulse	P <sub>PK</sub>	14	W
Maximum Junction Temperature	T <sub>J</sub>	150	°C

Stresses exceeding Maximum Ratings may damage the device. Maximum Ratings are stress ratings only. Functional operation above the Recommended Operating Conditions is not implied. Extended exposure to stresses above the Recommended Operating Conditions may affect device reliability.

1. All diodes under power



**ON Semiconductor®**

<http://onsemi.com>

### CIRCUIT DESCRIPTION

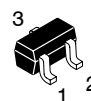
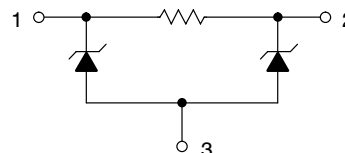

**SC-75  
CASE 463  
STYLE 4**

### MARKING DIAGRAM

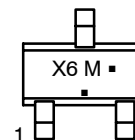

X6 = Device Code  
M = Date Code\*  
▪ = Pb-Free Package

(Note: Microdot may be in either location)

\*Date Code orientation may vary depending upon manufacturing location.

### ORDERING INFORMATION

Device	Package	Shipping†
NZF220TT1	SC-75	3000/Tape & Reel
NZF220TT1G	SC-75 (Pb-Free)	3000/Tape & Reel

†For information on tape and reel specifications, including part orientation and tape sizes, please refer to our Tape and Reel Packaging Specification Brochure, BRD8011/D.

# NZF220TT1

## ELECTRICAL CHARACTERISTICS

Characteristic	Symbol	Min	Typ	Max	Unit
Zener Breakdown Voltage, @ $I_{ZT} = 1 \text{ mA}$	$V_Z$	6.0	–	8.0	V
Zener Leakage Current, @ $V_R = 3 \text{ V}$	$I_r$	N/A	–	1.0	$\mu\text{A}$
Zener Forward Voltage, @ $I_F = 50 \text{ mA}$	$V_F$	N/A	–	1.25	V
Zener Internal Capacitance, @ 0 V Bias	C	7.0	–	10	pF
Zener/Resistor Array Line Capacitance	C	17.6	–	26.4	pF
Resistance	R	90	–	110	$\Omega$
Cutoff Frequency	$F_C$ (Note 2)	–	220	–	MHz

2. 50  $\Omega$  Source and 50  $\Omega$  Lead Termination per Figure 2

## Applications Information

### Suppressing Noise at the Source

- Filter all I/O signals leaving the noisy environment
- Locate I/O driver circuits close to the connector
- Use the longest rise/fall times possible for all digital signals

### Reducing Noise at the Receiver

- Filter all I/O signals entering the unit
- Locate the I/O filters as close as possible to the connector

### Minimizing Noise Coupling

- Use multilayer PCBs to minimize power and ground inductance
- Keep clock circuits away from the I/O connector
- Ground planes should be used whenever possible
- Minimize the loop area for all high speed signals
- Provide for adequate power decoupling

### ESD Protection

- Locate the suppression devices as close to the I/O connector as possible
- Minimize the PCB trace length to the suppression device
- Minimize the PCB trace length for the ground return for the suppression device

# NZF220TT1

## Frequency Response Specification

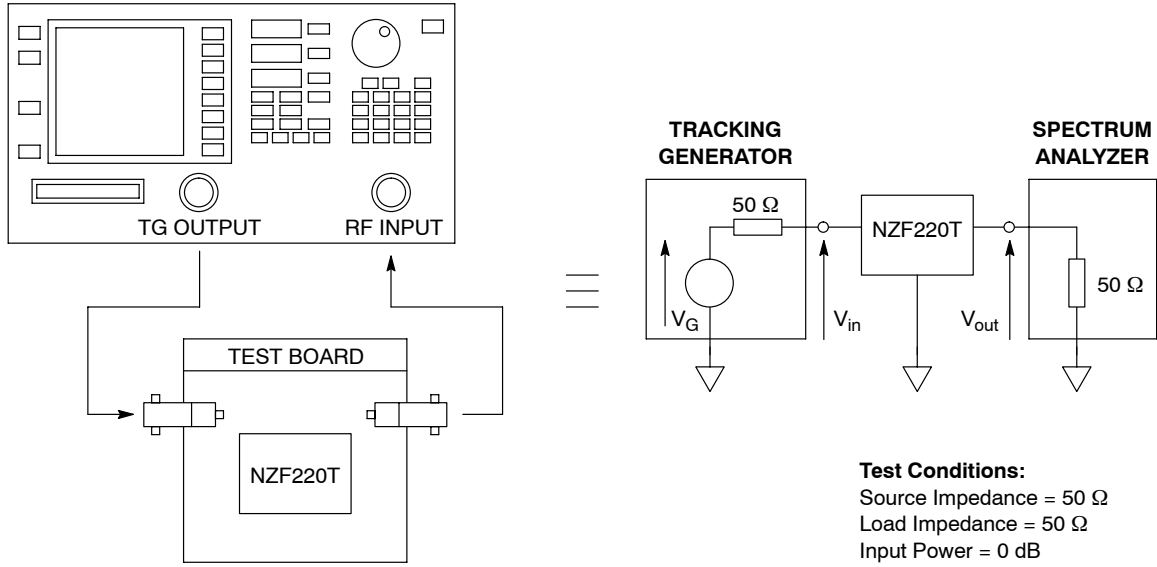

Figure 1. Measurement Conditions

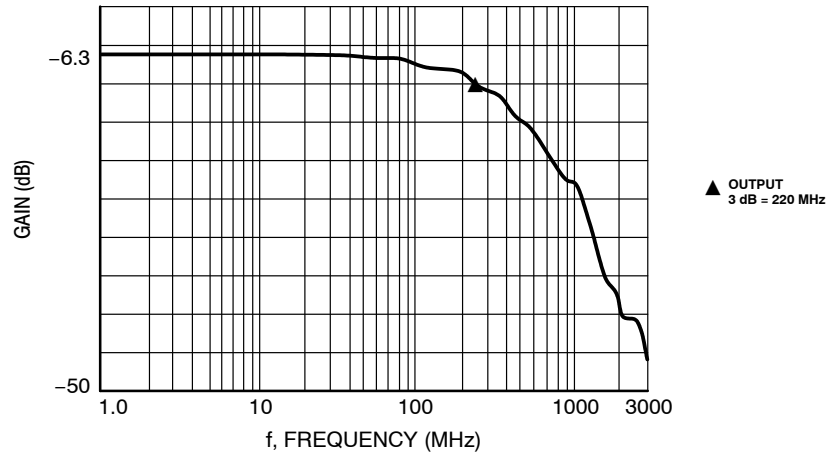
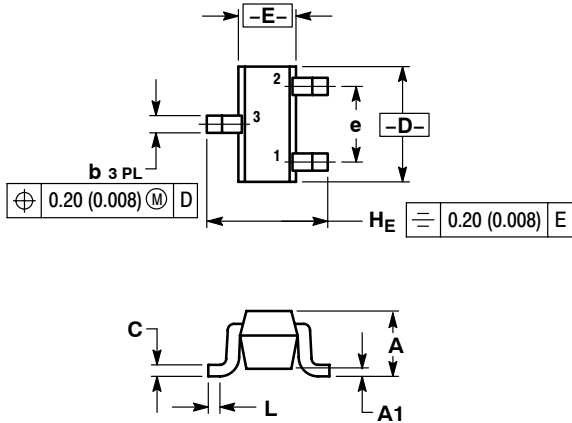

Figure 2. Typical EMI Filter Response  
 (50  $\Omega$  Source and 50  $\Omega$  Load Termination)

# NZF220TT1

## OUTLINE DIMENSIONS

SC-75/SOT-416  
CASE 463-01  
ISSUE F



- NOTES:  
1. DIMENSIONING AND TOLERANCING PER ANSI Y14.5M, 1982.  
2. CONTROLLING DIMENSION: MILLIMETER.

DIM	MILLIMETERS			INCHES		
	MIN	NOM	MAX	MIN	NOM	MAX
A	0.70	0.80	0.90	0.027	0.031	0.035
A1	0.00	0.05	0.10	0.000	0.002	0.004
b	0.15	0.20	0.30	0.006	0.008	0.012
C	0.10	0.15	0.25	0.004	0.006	0.010
D	1.55	1.60	1.65	0.059	0.063	0.067
E	0.70	0.80	0.90	0.027	0.031	0.035
e	1.00 BSC			0.04 BSC		
L	0.10	0.15	0.20	0.004	0.006	0.008
H <sub>E</sub>	1.50	1.60	1.70	0.061	0.063	0.065

- STYLE 4:  
PIN 1. CATHODE  
2. CATHODE  
3. ANODE

### SOLDERING FOOTPRINT\*

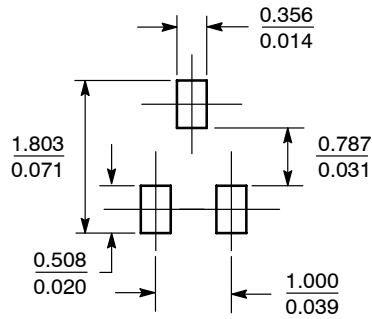

SCALE 10:1 (mm/inches)

\*For additional information on our Pb-Free strategy and soldering details, please download the ON Semiconductor Soldering and Mounting Techniques Reference Manual, SOLDERRM/D.

ON Semiconductor and are registered trademarks of Semiconductor Components Industries, LLC (SCILLC). SCILLC reserves the right to make changes without further notice to any products herein. SCILLC makes no warranty, representation or guarantee regarding the suitability of its products for any particular purpose, nor does SCILLC assume any liability arising out of the application or use of any product or circuit, and specifically disclaims any and all liability, including without limitation special, consequential or incidental damages. "Typical" parameters which may be provided in SCILLC data sheets and/or specifications can and do vary in different applications and actual performance may vary over time. All operating parameters, including "Typicals" must be validated for each customer application by customer's technical experts. SCILLC does not convey any license under its patent rights nor the rights of others. SCILLC products are not designed, intended, or authorized for use as components in systems intended for surgical implant into the body, or other applications intended to support or sustain life, or for any other application in which the failure of the SCILLC product could create a situation where personal injury or death may occur. Should Buyer purchase or use SCILLC products for any such unintended or unauthorized application, Buyer shall indemnify and hold SCILLC and its officers, employees, subsidiaries, affiliates, and distributors harmless against all claims, costs, damages, and expenses, and reasonable attorney fees arising out of, directly or indirectly, any claim of personal injury or death associated with such unintended or unauthorized use, even if such claim alleges that SCILLC was negligent regarding the design or manufacture of the part. SCILLC is an Equal Opportunity/Affirmative Action Employer. This literature is subject to all applicable copyright laws and is not for resale in any manner.

### PUBLICATION ORDERING INFORMATION

**LITERATURE FULFILLMENT:**  
Literature Distribution Center for ON Semiconductor  
P.O. Box 61312, Phoenix, Arizona 85082-1312 USA  
**Phone:** 480-829-7710 or 800-344-3860 Toll Free USA/Canada  
**Fax:** 480-829-7709 or 800-344-3867 Toll Free USA/Canada  
**Email:** orderlit@onsemi.com

**N. American Technical Support:** 800-282-9855 Toll Free  
USA/Canada

**Japan:** ON Semiconductor, Japan Customer Focus Center  
2-9-1 Kamimeguro, Meguro-ku, Tokyo, Japan 153-0051  
**Phone:** 81-3-5773-3850

**ON Semiconductor Website:** <http://onsemi.com>

**Order Literature:** <http://www.onsemi.com/litorder>

For additional information, please contact your local Sales Representative.