



Is Now Part of



ON Semiconductor®

To learn more about ON Semiconductor, please visit our website at

www.onsemi.com

ON Semiconductor and the ON Semiconductor logo are trademarks of Semiconductor Components Industries, LLC dba ON Semiconductor or its subsidiaries in the United States and/or other countries. ON Semiconductor owns the rights to a number of patents, trademarks, copyrights, trade secrets, and other intellectual property. A listing of ON Semiconductor's product/patent coverage may be accessed at www.onsemi.com/site/pdf/Patent-Marking.pdf. ON Semiconductor reserves the right to make changes without further notice to any products herein. ON Semiconductor makes no warranty, representation or guarantee regarding the suitability of its products for any particular purpose, nor does ON Semiconductor assume any liability arising out of the application or use of any product or circuit, and specifically disclaims any and all liability, including without limitation special, consequential or incidental damages. Buyer is responsible for its products and applications using ON Semiconductor products, including compliance with all laws, regulations and safety requirements or standards, regardless of any support or applications information provided by ON Semiconductor. "Typical" parameters which may be provided in ON Semiconductor data sheets and/or specifications can and do vary in different applications and actual performance may vary over time. All operating parameters, including "Typicals" must be validated for each customer application by customer's technical experts. ON Semiconductor does not convey any license under its patent rights nor the rights of others. ON Semiconductor products are not designed, intended, or authorized for use as a critical component in life support systems or any FDA Class 3 medical devices or medical devices with a same or similar classification in a foreign jurisdiction or any devices intended for implantation in the human body. Should Buyer purchase or use ON Semiconductor products for any such unintended or unauthorized application, Buyer shall indemnify and hold ON Semiconductor and its officers, employees, subsidiaries, affiliates, and distributors harmless against all claims, costs, damages, and expenses, and reasonable attorney fees arising out of, directly or indirectly, any claim of personal injury or death associated with such unintended or unauthorized use, even if such claim alleges that ON Semiconductor was negligent regarding the design or manufacture of the part. ON Semiconductor is an Equal Opportunity/Affirmative Action Employer. This literature is subject to all applicable copyright laws and is not for resale in any manner.

FPF3003

IntelliMAX™ Full Functional Input Power Path Management Switch for Dual-Battery Portable System

Features

- 2.3V to 5.5V Input Voltage Operating Range
- Low R_{ON} between Battery and Load
Maximum 50mΩ at $V_{IN} = 4.2V$
- Low R_{ON} between Charger and Battery
Maximum 125mΩ at $V_{IN} = 4.2V$
- Maximum DC Current for Load Switch: 2.5A
- Maximum DC Current for Charge Switch: 1.5A
- Slew Rate Controlled to 30μs Nominal Rise Time
- Seamless Break-Before-Make Transition
- Quiescent Current: 30μA Typical
- Thermal Shutdown
- Reverse Current Blocking (RCB) between Battery A and Battery B
- RESET Timer Delay: 7s Typical
- ESD Protected:
 - Human Body Model: >2.5kV
 - Charged Device Model: >1.5kV
 - IEC 61000-4-2 Air Discharge: >15kV
 - IEC 61000-4-2 Contact Discharge: >8kV
- 1.6mm X 1.6mm, 16-Bump, 0.4mm Pitch, WLCSP

Description

The FPF3003 is a single-chip solution for dual-battery power-path switching, including integrated P-channel switches and analog control features. The input voltage range operates from 2.3V to 5.5V. The device selects one of two batteries to provide power to the system, enabling one battery to be charged by the external battery charger.

The FPF3003 has battery voltage monitoring to determine if the battery is under voltage. Special driver and digital circuitry allows the device to switch quickly between battery A and battery B, which allows hot swapping of battery packs. Maximum current from battery to load per channel is limited to a constant 2.5A and internal thermal shutdown circuits protect the part during fault conditions.

The FPF3003 is available in a 1.6mm x 1.6mm, 16-bump, Wafer-Level Chip-Scale Package (WLCSP).

Applications

- Dual-Battery Cell phone
- Dual-Battery Portable Equipment

Ordering Information

Part Number	Top Mark	(Charger-Battery) Max. R_{ON} at 4.2V _{IN}	(Battery-Load) Max. R_{ON} at 4.2V _{IN}	Typical t_R	Package
FPF3003UCX	QW	125mΩ	50mΩ	30μs	16-Bump, 0.4mm Pitch, 1.6mm x 1.6mm WLCSP

Typical Application Diagram

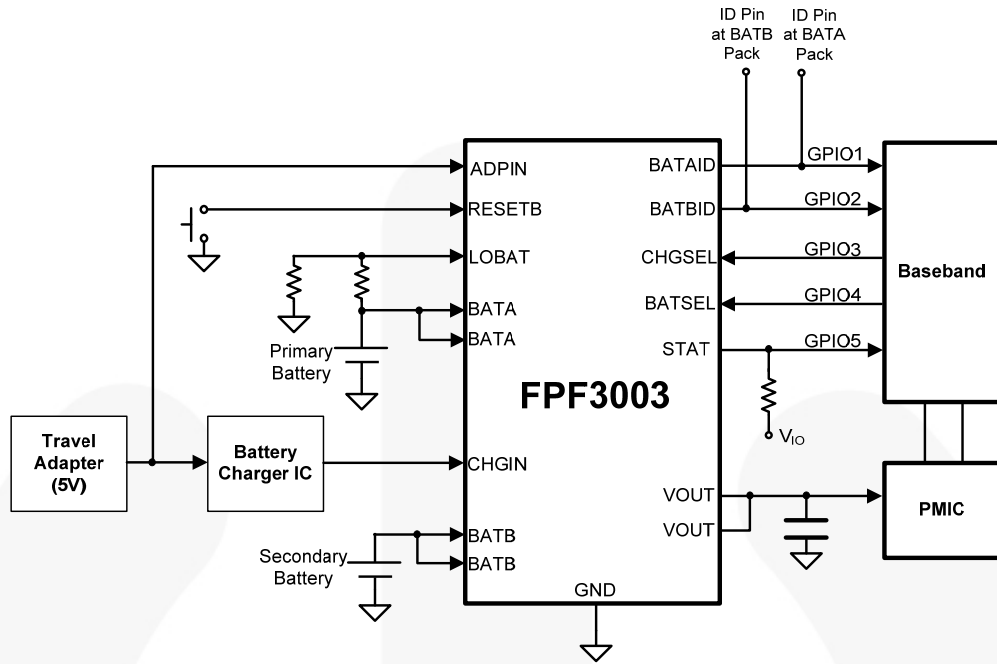

Figure 1. Typical Application

Functional Block Diagram

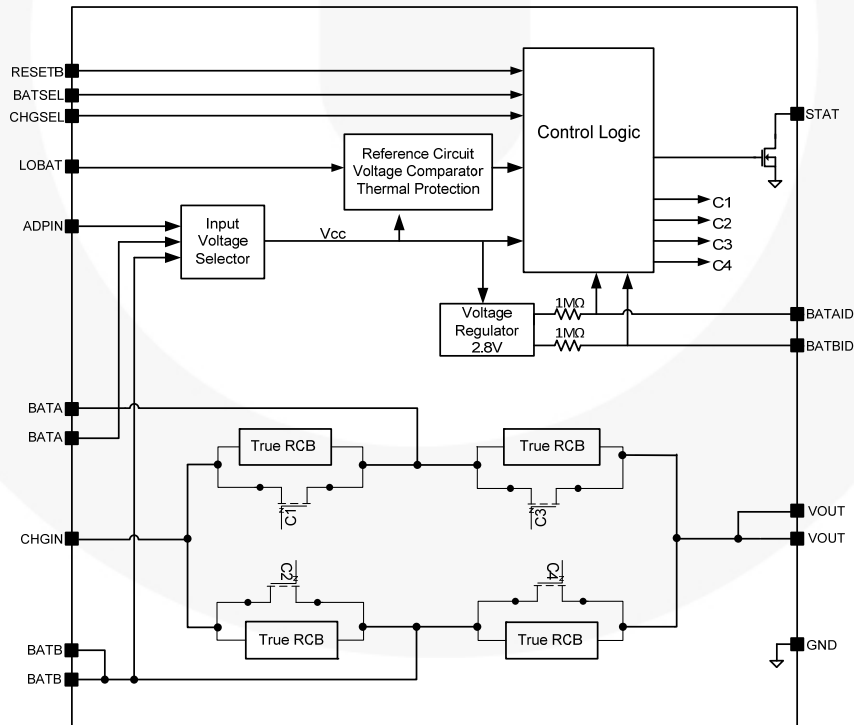

Figure 2. Functional Block Diagram

Pin Configuration

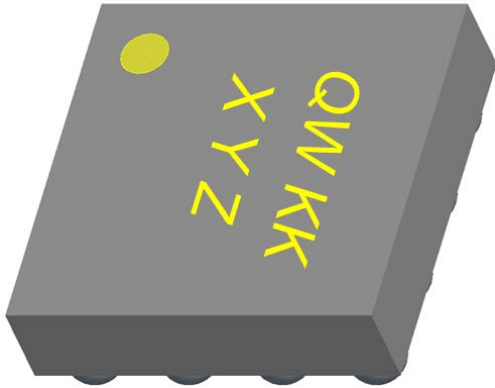

Figure 3. Pin Assignments (Top View)

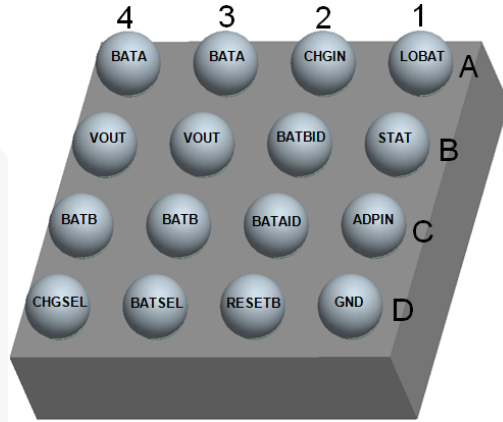

Figure 4. Pin Assignments (Bottom View)

Pin Description

Pin #	Name	Description
A1	LOBAT	Low Battery A Voltage Input. Connect to the resistive divider to set the trip level for chip-on moment. If LOBAT is less than 0.8V, V_{OUT} is connected to BATB.
A2	CHGIN	Charging Input. Charging path input.
A3, A4	BATA	Supply Input. Battery A voltage input.
B1	STAT	Battery Selector Status. Open-drain output. HIGH (Hi-Z) means battery A connects to VOUT. LOW means battery B connects to VOUT.
B2	BATBID	Battery B Indicator. Connect this pin with the ID pin at the battery pack of BATB. HIGH means battery B absent; LOW means battery B present.
B3, B4	VOUT	Switch Output. Connect to system load.
C1	ADPIN	Adapter Input. 5V input for battery charger.
C2	BATAID	Battery A Indicator. Connect this pin with the ID pin at the battery pack of BATA. HIGH means battery A absent; LOW means battery A present.
C3, C4	BATB	Supply Input. Battery B voltage input.
D1	GND	Ground
D2	RESETB	Reset Input. Active LOW. Both system path switches are disconnected from system load.
D3	BATSEL	Battery Selection Input. HIGH means to switch battery B to VOUT; LOW means to switch battery A to VOUT.
D4	CHGSEL	Charge Selection Input. HIGH means to charge battery B; LOW means to charge battery A.

Absolute Maximum Ratings

Stresses exceeding the Absolute Maximum Ratings may damage the device. The device may not function or be operable above the recommended operating conditions and stressing the parts to these levels is not recommended. In addition, extended exposure to stresses above the recommended operating conditions may affect device reliability. The absolute maximum ratings are stress ratings only.

Symbol	Parameters		Min.	Max.	Unit
V_{IN}	All Pins To GND		-0.3	6.0	V
I_{SW}	Maximum Continuous Switch Current to Load			2.5	A
	Maximum Continuous Switch Current to Charger			1.5	A
P_D	Power Dissipation at $T_A = 25^\circ\text{C}$			1.7	W
T_{STG}	Operating and Storage Junction Temperature		-65	150	$^\circ\text{C}$
Θ_{JA}	Thermal Resistance, Junction to Ambient (1in. Square Pad of 2oz. Copper)			72 ⁽¹⁾	$^\circ\text{C/W}$
ESD	Electrostatic Discharge Capability	Human Body Model, JESD22-A114	2.5		kV
		Charged Device Model, JESD22-C101	1.5		
		Air Discharge (BATA, BATB, ADPIN to GND), IEC61000-4-2 System Level	15.0		
		Contact Discharge (BATA, BATB, ADPIN to GND), IEC61000-4-2 System Level	8.0		

Note:

1. Measured using 2S2P JEDEC std. PCB.

Recommended Operating Conditions

The Recommended Operating Conditions table defines the conditions for actual device operation. Recommended operating conditions are specified to ensure optimal performance to the datasheet specifications. Fairchild does not recommend exceeding them or designing to Absolute Maximum Ratings.

Symbol	Parameters		Min.	Max.	Unit
V_{IN}	ADPIN		4.6	5.5	V
	BATA, BATB		2.3	5.5	V
T_A	Ambient Operating Temperature		-40	85	$^\circ\text{C}$

Electrical Characteristics

ADPIN=4.6 to 5.5V, $V_{BATA}=V_{BATB}=2.3$ to 5.5V, $T_A=-40$ to 85°C unless otherwise noted. Typical values are at ADPIN=5V, CHGIN= $V_{BATA}=V_{BATB}=4.2$ V, RESETB=HIGH, and $T_A=25^\circ\text{C}$.

Symbol	Parameters	Condition	Min.	Typ.	Max.	Unit	
Static Characteristics							
V_{ADPIN}	Adapter Input Voltage		4.6		5.5	V	
V_{ADPIN_TH}	ADPIN Threshold	ADPIN Rising		4.5		V	
		ADPIN Falling		4.2			
V_{BATA}, V_{BATB}	Battery Input Voltage		2.3		5.5	V	
I_Q	Quiescent Current	$I_{OUT}=0\text{mA}$		30		μA	
R_{ON}	On Resistance to Load Switch, BATA or BATB to VOUT	$V_{BATA}=V_{BATB}=5.5\text{V}, I_{OUT}=300\text{mA}, T_A=25^\circ\text{C}^{(2)}$		34		m Ω	
		$V_{BATA}=V_{BATB}=4.2\text{V}, I_{OUT}=300\text{mA}, T_A=25^\circ\text{C}$		38	50		
		$V_{BATA}=V_{BATB}=3.7\text{V}, I_{OUT}=300\text{mA}, T_A=25^\circ\text{C}$		43	55		
		$V_{BATA}=V_{BATB}=2.3\text{V}, I_{OUT}=300\text{mA}, T_A=25^\circ\text{C}^{(2)}$		62			
	On Resistance to Charger Switch, CHGIN to BATA	$V_{BATA}=V_{BATB}=5.5\text{V}, I_{CHG}=200\text{mA}, T_A=25^\circ\text{C}^{(2)}$		66			
		$V_{BATA}=V_{BATB}=4.2\text{V}, I_{CHG}=200\text{mA}, T_A=25^\circ\text{C}$		73	90		
		$V_{BATA}=V_{BATB}=3.7\text{V}, I_{CHG}=200\text{mA}, T_A=25^\circ\text{C}$		80	95		
		$V_{BATA}=V_{BATB}=2.3\text{V}, I_{CHG}=200\text{mA}, T_A=25^\circ\text{C}^{(2)}$		101			
	On Resistance to Charger Switch, CHGIN to BATB	$V_{BATA}=V_{BATB}=5.5\text{V}, I_{CHG}=200\text{mA}, T_A=25^\circ\text{C}^{(2)}$		92			
		$V_{BATA}=V_{BATB}=4.2\text{V}, I_{CHG}=200\text{mA}, T_A=25^\circ\text{C}$		99	125		
		$V_{BATA}=V_{BATB}=3.7\text{V}, I_{CHG}=200\text{mA}, T_A=25^\circ\text{C}$		105	130		
		$V_{BATA}=V_{BATB}=2.3\text{V}, I_{CHG}=200\text{mA}, T_A=25^\circ\text{C}^{(2)}$		128			
V_{IH}	Input Logic HIGH Voltage	$V_{BATA}=V_{BATB}=2.3\text{V} - 5.5\text{V}, \text{CHGSEL}, \text{BATSEL}$	0.90			V	
		$V_{BATA}=V_{BATB}=2.3\text{V} - 5.5\text{V}, \text{RESETB}$	1.15				
		$V_{BATA}=V_{BATB}=2.3\text{V} - 5.5\text{V}, \text{BATAID}, \text{BATBID}$	1.70				
V_{IL}	Input Logic LOW Voltage	$V_{BATA}=V_{BATB}=2.3\text{V} - 5.5\text{V}, \text{CHGSEL}, \text{BATSEL}$			0.6	V	
		$V_{BATA}=V_{BATB}=2.3\text{V} - 5.5\text{V}, \text{RESETB}$			0.8		
		$V_{BATA}=V_{BATB}=2.3\text{V} - 5.5\text{V}, \text{BATAID}, \text{BATBID}$			0.9		
V_{STAT_LO}	STAT Logic LOW Voltage	$I_{SINK}=1\text{mA}$			0.3	V	
V_{LOBAT}	LOBAT Threshold	$V_{BATA}=V_{BATB}=2.3\text{V} - 5.5\text{V}$		0.8		V	
t_{LOBAT}	LOBAT De-Glitch Time	$V_{BATA}=V_{BATB}=2.3\text{V} - 5.5\text{V}$		1.3		ms	
T_{SD}	Thermal Shutdown	Shutdown Threshold		150		$^\circ\text{C}$	
		Return from Shutdown		140			
		Hysteresis		10			
V_{DROOP_OUT}	Output Voltage Droop while Battery Switching	$V_{BATA}=4.2\text{V}, V_{BATB}=4.2\text{V}, \text{Switching from } V_{BATA} \rightarrow V_{BATB}, R_L=100\Omega, C_{OUT}=10\mu\text{F}$			100	mV	

Continued on the following page...

Electrical Characteristics

ADPIN=4.6 to 5.5V, $V_{BATA}=V_{BATB}=2.3$ to 5.5V, $T_A=-40$ to 85°C unless otherwise noted. Typical values are at ADPIN=5V, CHGIN= $V_{BATA}=V_{BATB}=4.2$ V, RESETB=HIGH, and $T_A=25^\circ\text{C}$.

Symbol	Parameters	Condition	Min.	Typ.	Max.	Unit
Reverse Current Blocking between V_{BATA} and V_{BATB}						
V_{T_RCB}	RCB Protection Trip Point	$V_{OUT} - V_{BATA}$ or V_{BATB}		20		mV
V_{R_RCB}	RCB Protection Release Trip Point	V_{BATA} or $V_{BATB} - V_{OUT}$		30		mV
	Hysteresis			50		mV
Dynamic Characteristics: See Definitions Below						
t_R	V_{OUT} Rise Time ^(2,3,4)	$V_{BATA}=V_{BATB}=4.2\text{V}$, $R_L=100\Omega$, $T_A=25^\circ\text{C}$, $C_L=10\mu\text{F}$, BATAID=HIGH to LOW, BATBID=HIGH		30		μs
t_{DON}	Turn-On Delay ^(2,3,4)			5		μs
t_{ON}	Turn-On Time ^(2,3,4)			35		
t_F	V_{OUT} Fall Time ^(2,3,5)	$V_{BATA}=V_{BATB}=4.2\text{V}$, $R_L=100\Omega$, $T_A=25^\circ\text{C}$, $C_L=10\mu\text{F}$, BATAID=LOW to HIGH, BATBID=HIGH		2.5		ms
t_{DOFF}	Turn-Off Delay ^(2,3,5)			0.1		ms
t_{OFF}	Turn-Off Time ^(2,3,5)			2.6		ms
t_{DSEL}	Selection Delay ^(2,3)	$V_{BATA}=V_{BATB}=4.2\text{V}$, $R_L=100\Omega$, $T_A=25^\circ\text{C}$, $C_L=10\mu\text{F}$, CHGSEL or BATSEL=LOW to HIGH		1		ms
t_{DRST}	RESET Timer Delay ^(2,3)	$V_{BATA}=V_{BATB}=4.2\text{V}$, $R_L=100\Omega$, $T_A=25^\circ\text{C}$, $C_L=10\mu\text{F}$, RESETB=Floating to LOW		7		s

Notes:

- This parameter is guaranteed by design and characterization; not production tested.
- $t_{DON}/t_{DOFF}/t_R/t_F$ is defined in Figure 5.
- $t_{ON}=t_R + t_{DON}$.
- $t_{OFF}=t_F + t_{DOFF}$.

Timing Diagram

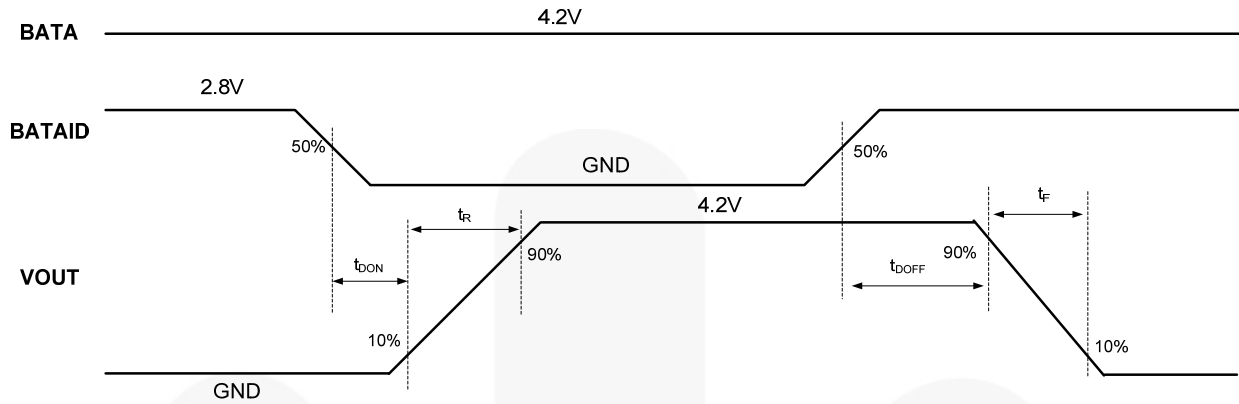

Figure 5. ON/OFF Behavior ($V_{BATA}=4.2V$)

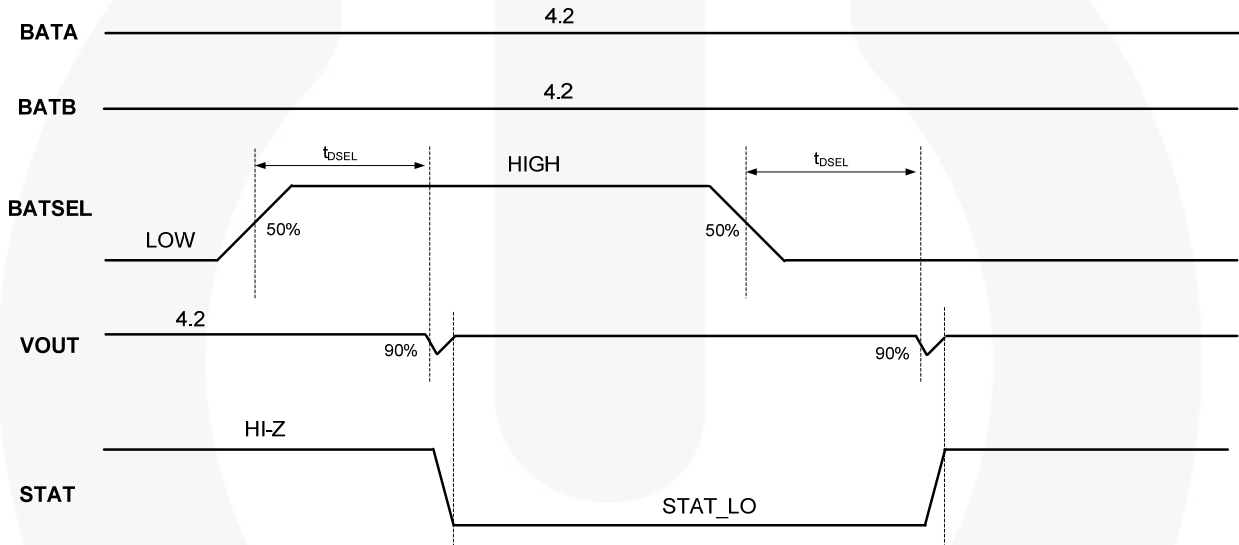

Figure 6. Battery-to-System Path Selection Behavior by BATSEL ($V_{BATA}=V_{BATB}=4.2V$)

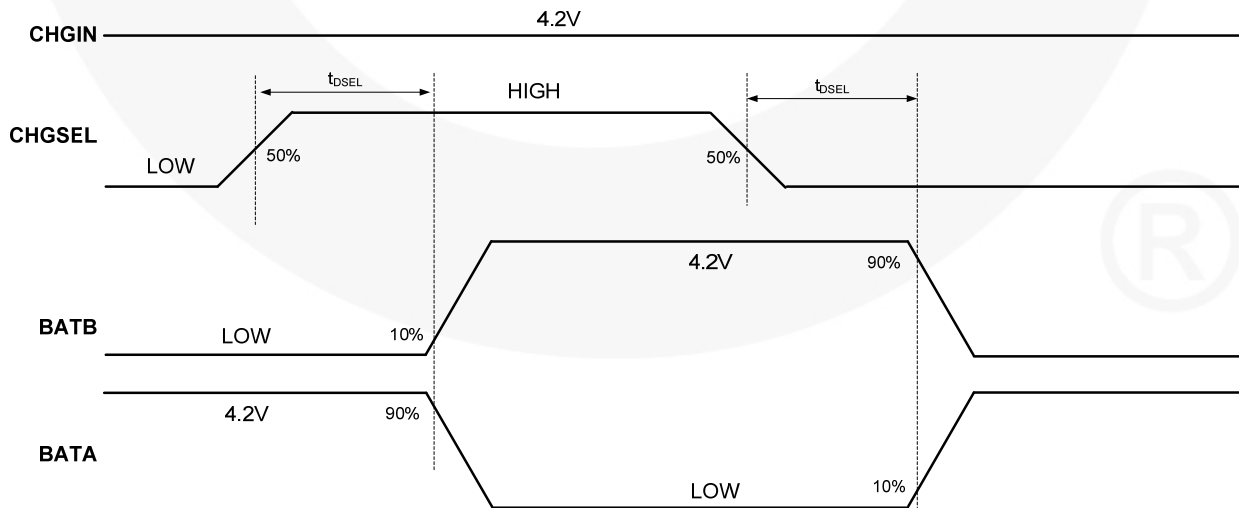

Figure 7. Charging Path Selection Behavior by CHGSEL
($ADPIN=5V$, $CHGIN=4.2V$, $V_{BATA}=V_{BATB}=Floating$ with $1\mu F$)

Timing Diagrams (Continued)

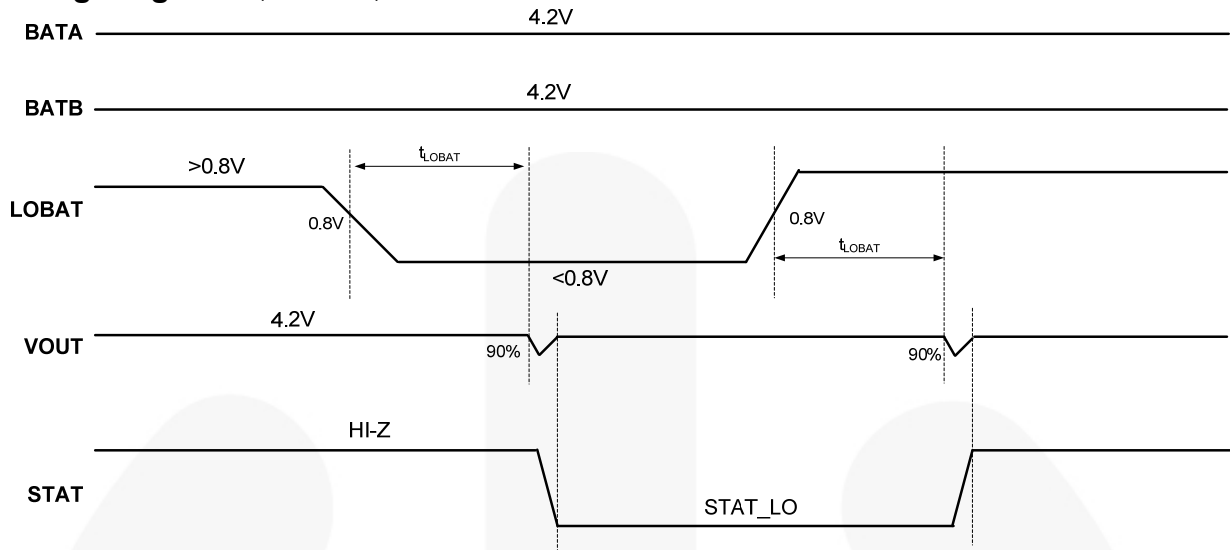

Figure 8. Transition from V_{BATA} to V_{BATB} Behavior by LOBAT ($V_{BATA}=V_{BATB}=4.2V$)

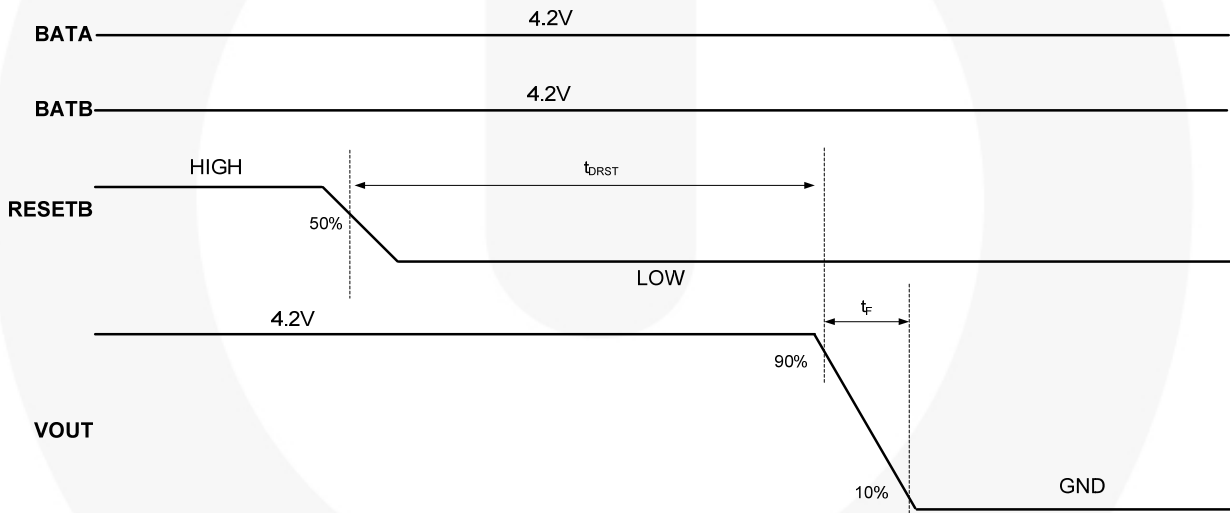

Figure 9. System Reset Behavior by RESETB ($V_{BATA}=V_{BATB}=4.2V$)

Typical Characteristics

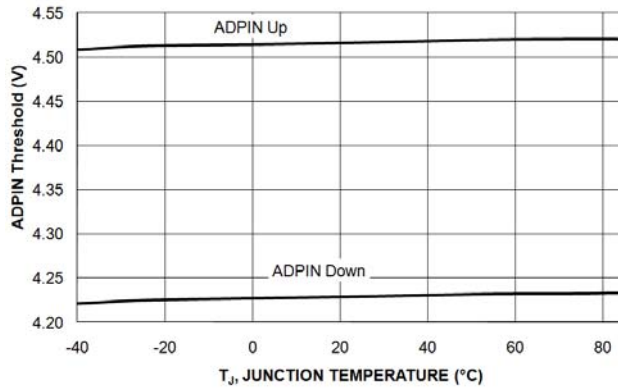

Figure 10. ADPIN vs. Temperature

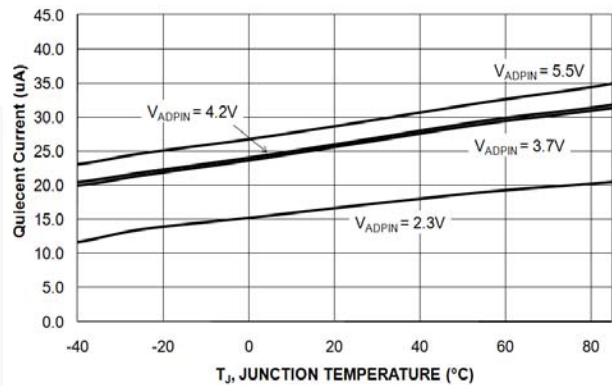

Figure 11. Supply Current vs. Temperature

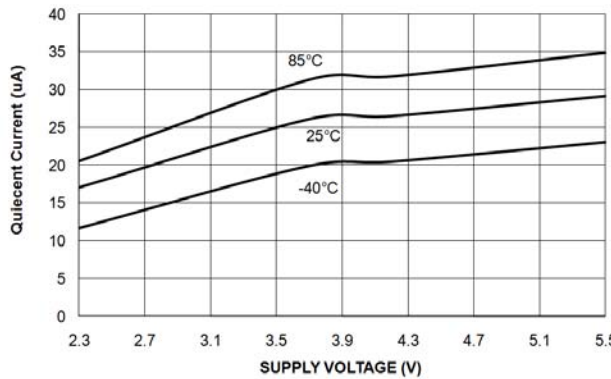

Figure 12. Supply Current vs. Supply Voltage

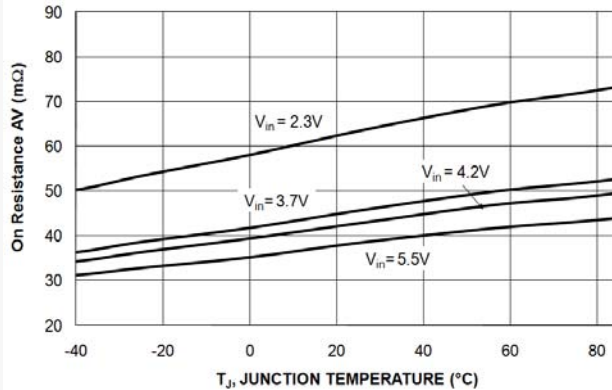

Figure 13. R_{ON} (V_{BATA} or V_{BATB} to V_{OUT}) vs. Temperature

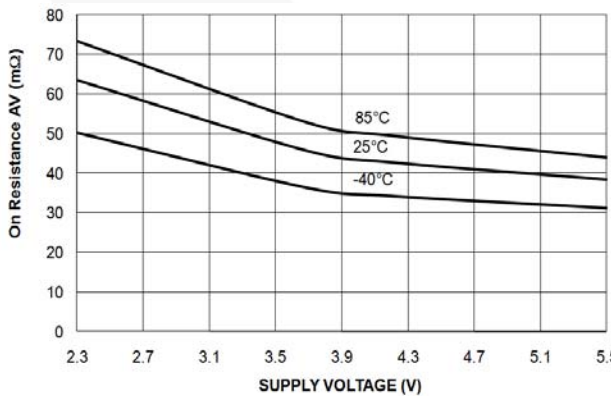

Figure 14. R_{ON} (V_{BATA} or V_{BATB} to V_{OUT}) vs. Supply Voltage

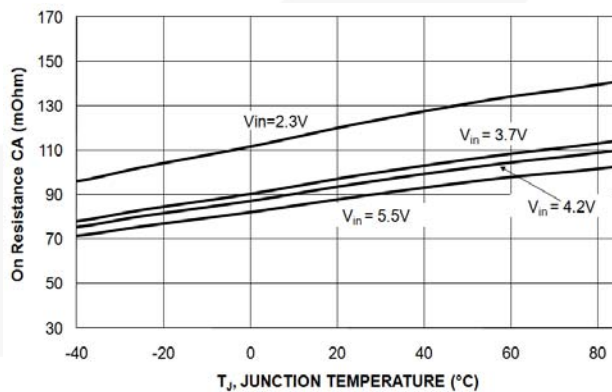

Figure 15. R_{ON} ($CHGIN$ to V_{BATA}) vs. Temperature

Typical Characteristics

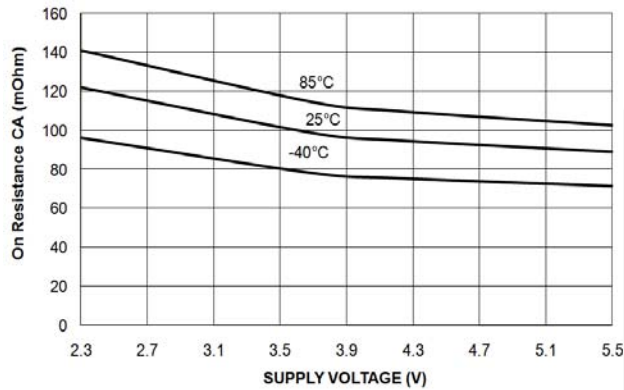

Figure 16. R_{ON} (CHGIN to V_{BATA}) vs. Supply Voltage

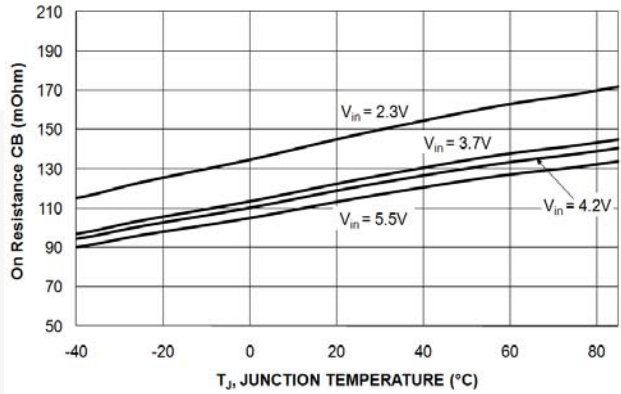

Figure 17. R_{ON} (CHGIN to V_{BATB}) vs. Temperature

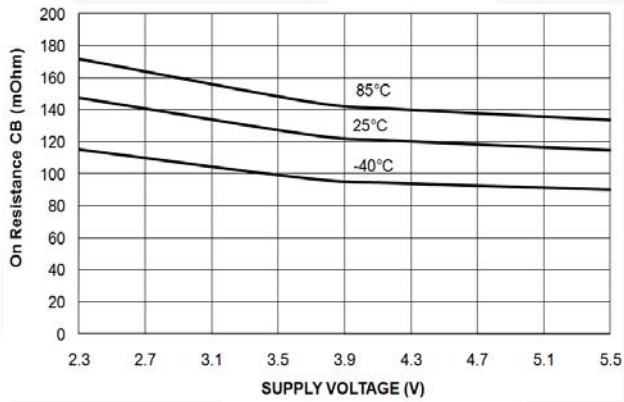

Figure 18. R_{ON} (CHGIN to V_{BATB}) vs. Supply Voltage

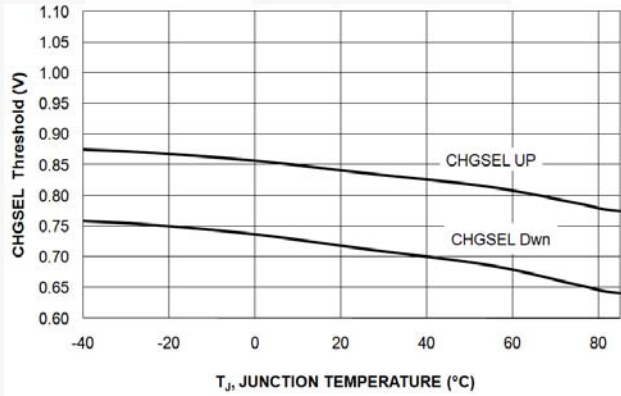

Figure 19. CHGSEL vs. Temperature

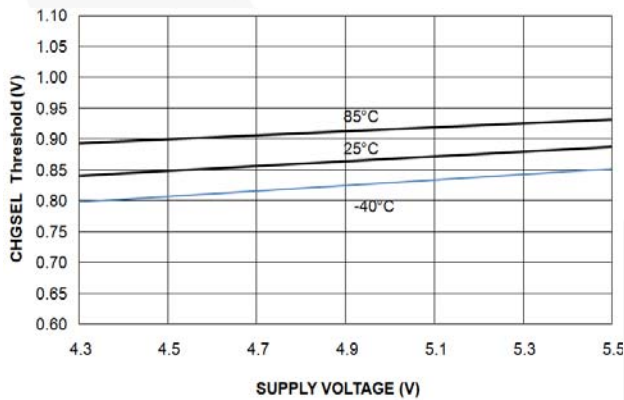

Figure 20. CHGSEL vs. ADPIN Voltage

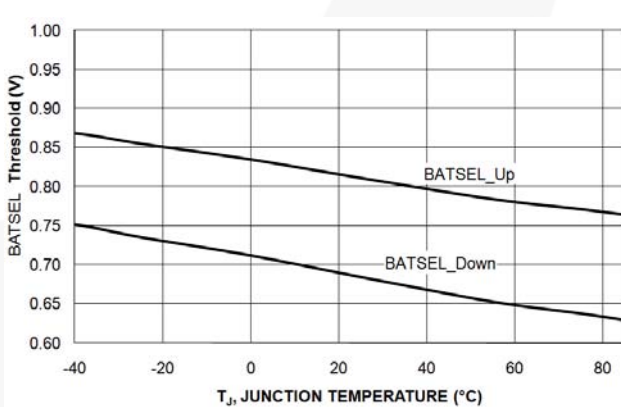

Figure 21. BATSEL vs. Temperature

Typical Characteristics

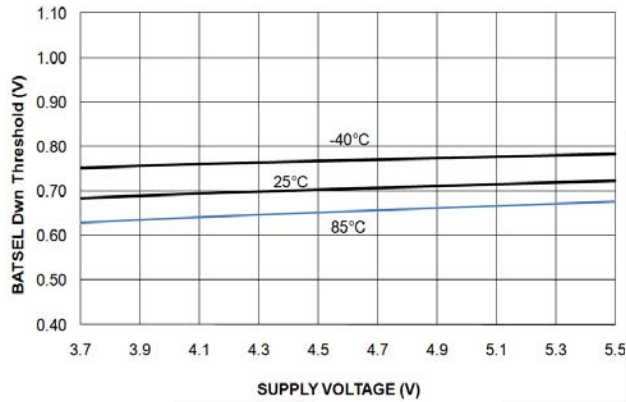

Figure 22. BATSEL vs. Supply Voltage

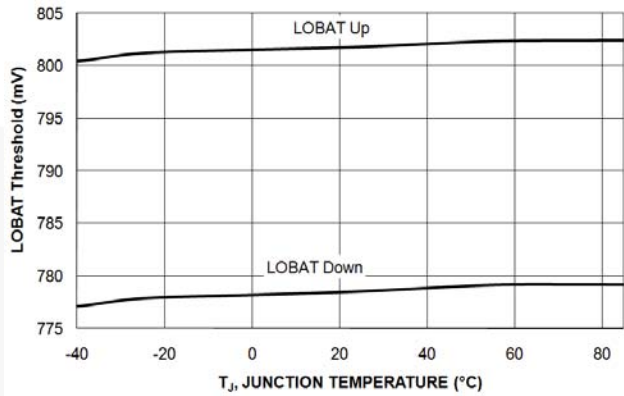

Figure 23. LOBAT vs. Temperature

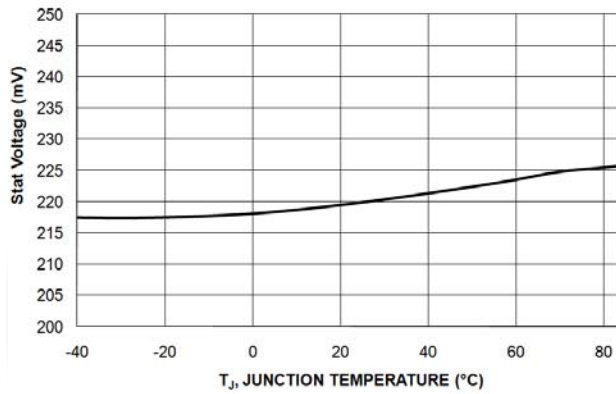

Figure 24. STAT LOW vs. Temperature

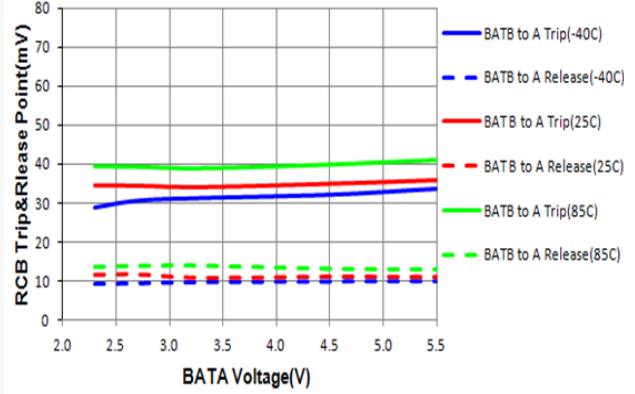

Figure 25. RCB (V_{BATA} and V_{OUT}) vs. Temperature

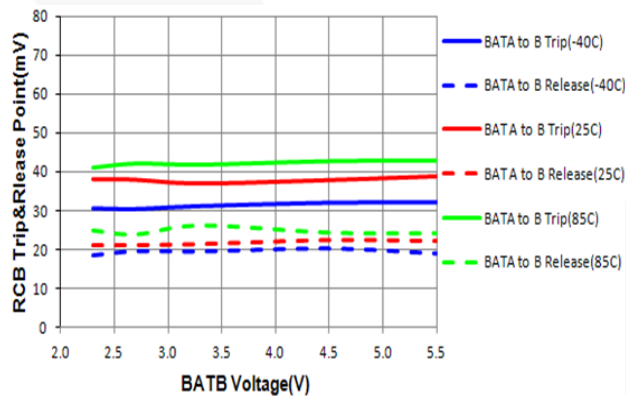

Figure 26. RCB (V_{BATB} and V_{OUT}) vs. Temperature

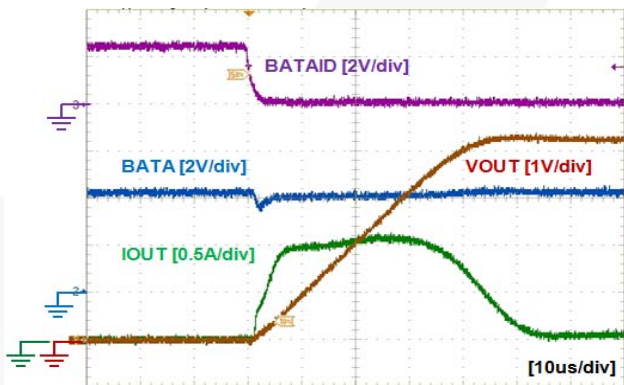

Figure 27. Turn-On Response
($V_{BATA}=4.2V$, $C_{OUT}=10\mu F$, $R_L=100\Omega$)

Typical Characteristics

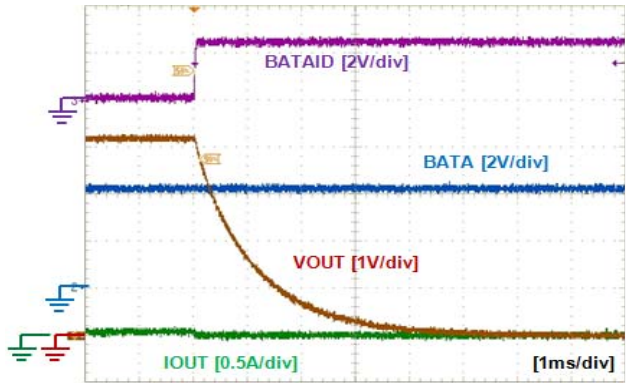

Figure 28. Turn-Off Response
 ($V_{BATA}=4.2V$, $C_{OUT}=10\mu F$, $R_L=100\Omega$)

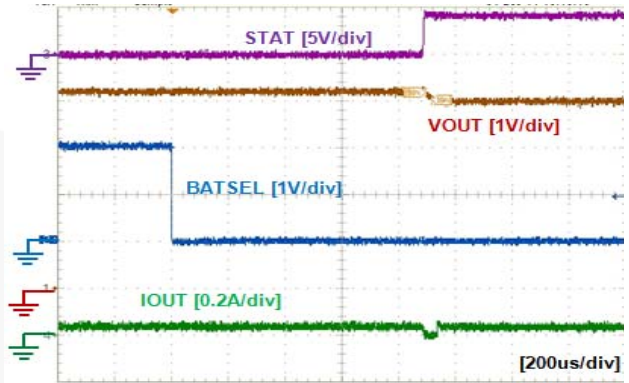

Figure 29. Battery Selection by BATSEL = HIGH to LOW
 ($V_{BATA}=4V$, $V_{BATB}=4.2V$, $C_{OUT}=100\mu F$, $R_L=100\Omega$)

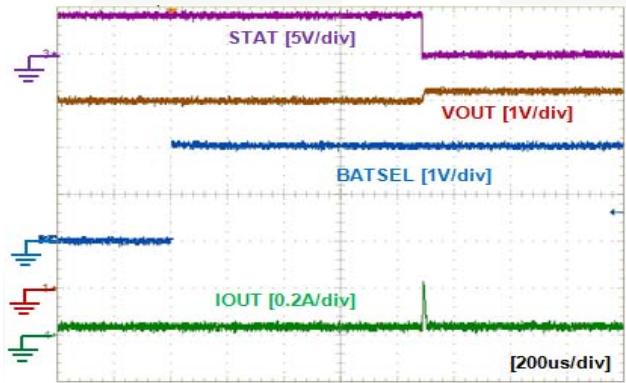

Figure 30. Battery Selection by BATSEL = LOW to HIGH
 ($V_{BATA}=4V$, $V_{BATB}=4.2V$, $C_{OUT}=10\mu F$, $R_L=100\Omega$)

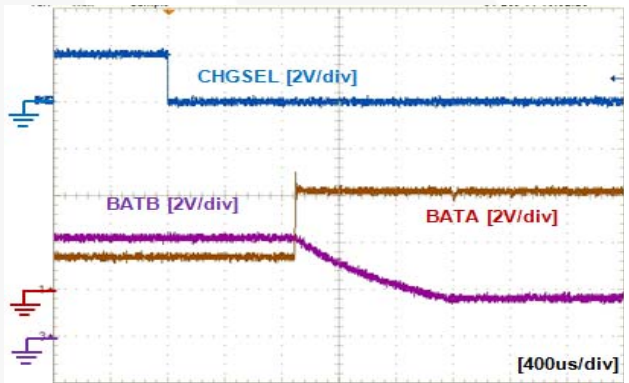

Figure 31. Charge Path Selection by CHGSEL = HIGH to LOW
 ($V_{CHGIN}=4V$, $V_{BATA}=V_{BATB}$ =Floating with $1\mu F$)

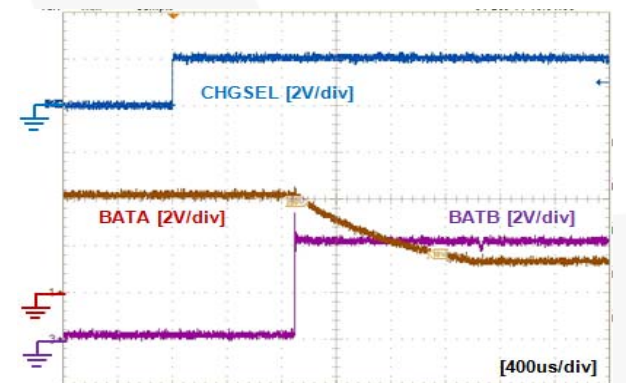

Figure 32. Charge Path Selection by CHGSEL = HIGH to LOW
 ($V_{CHGIN}=4V$, $BATA=BATB$ =Floating with $1\mu F$)

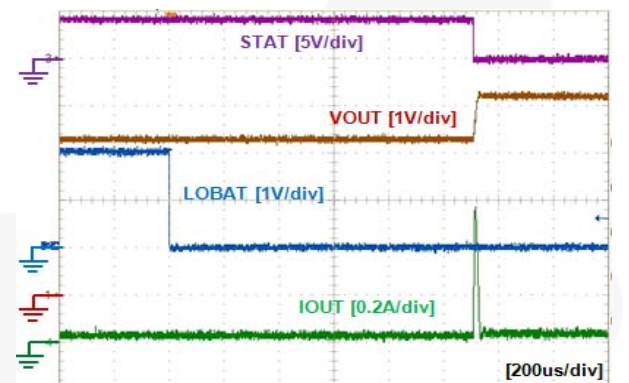

Figure 33. Battery Selection by LOBAT = HIGH to LOW
 ($V_{BATA}=3.8V$, $V_{BATB}=4.2V$, $C_{OUT}=100\mu F$, $R_L=100\Omega$)

Typical Characteristics

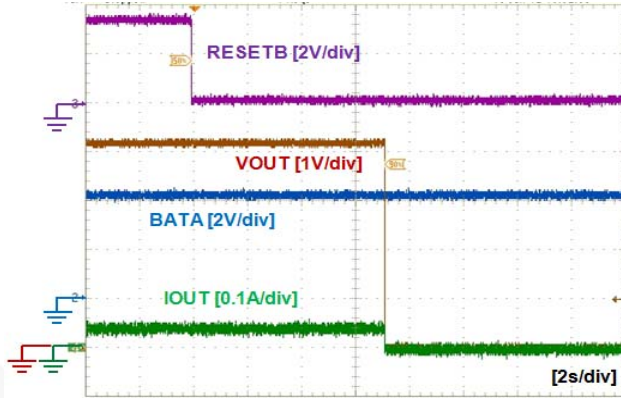

Figure 34. System Reset by RESETB: HIGH → LOW ($V_{BATA}=V_{BATB}=4.2V$, $C_{OUT}=100\mu F$, $R_L=100\Omega$)

Operation and Application Information

The FPF3003 is a low- R_{ON} , P-channel-based, input-source-selection power management switch for dual-battery systems. The FPF3003 input operating range is from 2.3V to 5.5V on BATA and BATB, while ADPIN has a range of 4.6V to 5.5V.

The FPF3003 controls the charging path from the charger to the battery with up to 1.5A and the discharging path from the battery to system load with up to 2.5A. The system or PMIC selects one of two batteries to provide power and enables one of the batteries to be charged by the external battery charger.

The FPF3003 has 30 μ s slew-rate control to reduce inrush current when engaged and thermal shutdown protection for reliable system operation.

The internal circuit is powered from the highest voltage source among BATA, BATB, and ADPIN.

Battery Presence Detection

The FPF3003 monitors whether or not a battery is present via the BATAID and BATBID pins. If any of these pins are LOW; FPF3003 recognizes the battery is present. Each pin is connected with an internal LDO output, so no pull-up resistor is required.

Output Capacitor

During battery source transition, voltage droop depends on output capacitance and load current condition. Advanced break-before-make operation minimizes the droop with minimum capacitance. At least 10 μ F is a good starting value in design.

Primary Battery Under-Voltage Set

FPF3003 monitors the primary battery of BATA for under-voltage condition. Once under-voltage condition is confirmed, the system power source changes from BATA to valid BATB automatically.

The under-voltage threshold level can be programmed with 0.8V of LOBAT and R divider (R1 and R2) as:

$$\frac{R1}{R2} = \frac{BATA_LO}{0.8} - 1 \quad (1)$$

where BATA_LO = Low BATA threshold to set.

If 3.4V of BATA is desired, R1/R2=3.25. If R2 is chosen 1M Ω , R1 is 3.25M Ω . Higher R2 is recommended to reduce leakage current from BATA.

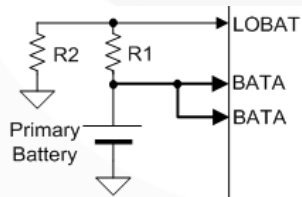

Figure 35. BATA Under-Voltage Level Setting

LOBAT has a 1.3ms of deglitch time to ensure BATA is in true under-voltage rather than transient battery voltage drop during GSM transmission operation.

Battery Selection

The load path can be controlled by the BATSEL pin. When BATSEL is LOW, the system is powered from BATA. When BATSEL is HIGH, BATB powers the system.

Figure 36 is state diagram showing how the power path from battery to system is determined.

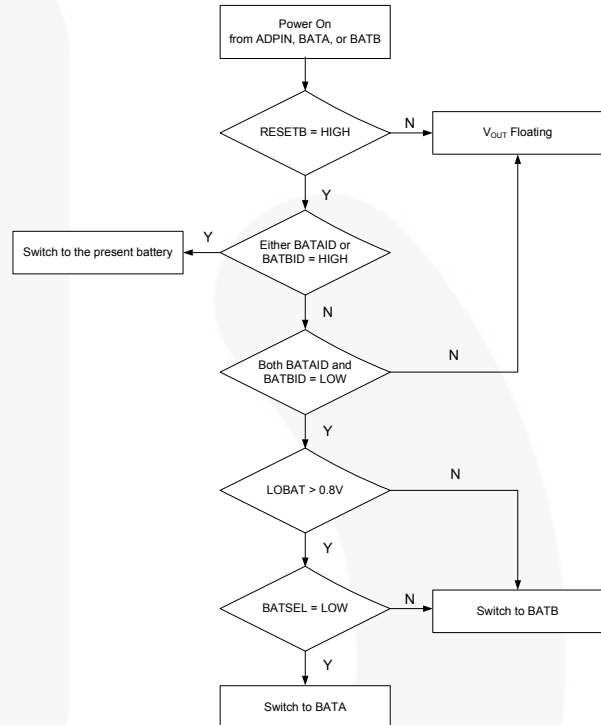

Figure 36. Power Path from Battery to System

The open-drain STAT pin is used to determine which battery powers the system. STAT becomes LOW if BATB is connected to the system. STAT is HIGH (HI-Z) if BATA is connected.

Battery Charging Path Selection

The charging path can be controlled by the CHGSEL pin. When CHGSEL is LOW, BATA can be charged from the charger. When CHGSEL is HIGH, BATB can be charged from the charger.

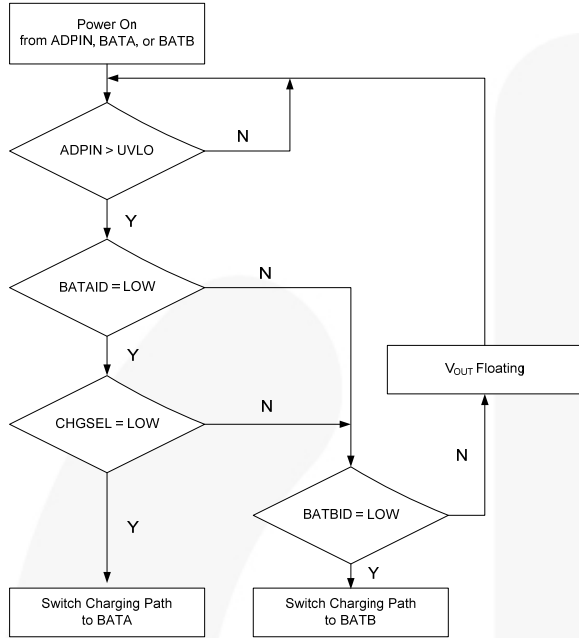

Figure 37. Battery Charging Path

System RESET

The RESETB pin allows the system to be turned off without detaching the battery pack. It has typical 7s delay to avoid transient abnormal signal.

Board Layout

For best performance, all power traces (BATA, BATB, CHGIN, ADPIN, and VOUT) should be as short as possible to minimize the parasitic electrical effects and the case-to-ambient thermal impedance. The output capacitor should be placed close to the device to minimize parasitic trace inductance.

Packaging Information

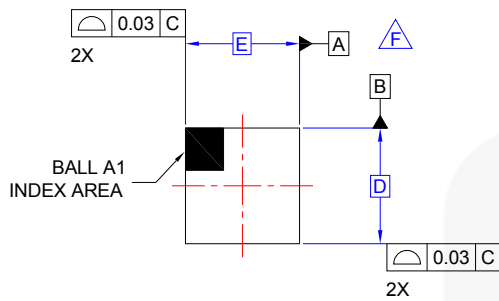

TOP VIEW

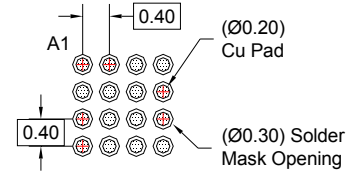

RECOMMENDED LAND PATTERN (NSMD PAD TYPE)

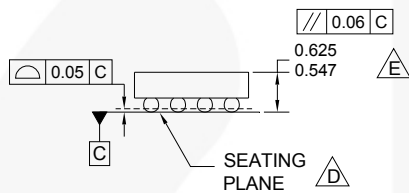

SIDE VIEWS

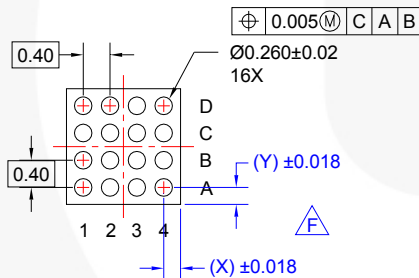
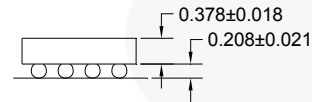

BOTTOM VIEW

NOTES:

- A. NO JEDEC REGISTRATION APPLIES.
- B. DIMENSIONS ARE IN MILLIMETERS.
- C. DIMENSIONS AND TOLERANCE PER ASME Y14.5M, 1994.
- D. DATUM C IS DEFINED BY THE SPHERICAL CROWNS OF THE BALLS.
- E. PACKAGE NOMINAL HEIGHT IS 586 MICRONS ±39 MICRONS (547-625 MICRONS).
- F. FOR DIMENSIONS D, E, X, AND Y SEE PRODUCT DATASHEET.
- G. DRAWING FILNAME: MKT-UC016AArev2.

Figure 38. 1.6mmx1.6mm WLCSP, 16-Bumps 0.4mm Pitch

Product-Specific Dimensions

Product	D	E	X	Y
FPF3003UCX	1560µm ±30µm	1560µm ±30µm	180µm	180µm

Package drawings are provided as a service to customers considering Fairchild components. Drawings may change in any manner without notice. Please note the revision and/or date on the drawing and contact a Fairchild Semiconductor representative to verify or obtain the most recent revision. Package specifications do not expand the terms of Fairchild's worldwide terms and conditions, specifically the warranty therein, which covers Fairchild products.

Always visit Fairchild Semiconductor's online packaging area for the most recent package drawings:
<http://www.fairchildsemi.com/packaging/>



TRADEMARKS

The following includes registered and unregistered trademarks and service marks, owned by Fairchild Semiconductor and/or its global subsidiaries, and is not intended to be an exhaustive list of all such trademarks.

- | | | | |
|--|--|---|---|
| 2Cool™ | F-PFS™ | PowerTrench® | The Power Franchise® |
| AccuPower™ | FRFET® | PowerXS™ | the power franchise™ |
| AX-CAP™* | Global Power Resource™ | Programmable Active Droop™ | TinyBoost™ |
| BitSiC™ | GreenBridge™ | QFET® | TinyBuck™ |
| Build it Now™ | Green FPS™ | QS™ | TinyCalc™ |
| CorePLUS™ | Green FPS™ e-Series™ | Quiet Series™ | TinyLogic® |
| CorePOWER™ | Gmax™ | RapidConfigure™ | TINYOPTO™ |
| CROSSVOLT™ | GTO™ |  ™ | TinyPower™ |
| CTL™ | IntelliMAX™ | Saving our world, 1mW/W/kW at a time™ | TinyPWM™ |
| Current Transfer Logic™ | ISOPLANAR™ | SignalWise™ | TinyWire™ |
| DEUXPEED® | Making Small Speakers Sound Louder and Better™ | SmartMax™ | TranSiC™ |
| Dual Cool™ | MegaBuck™ | SMART START™ | TriFault Detect™ |
| EcoSPARK® | MICROCOUPLER™ | Solutions for Your Success™ | TRUECURRENT®* |
| EfficientMax™ | MicroFET™ | SPM® | µSerDes™ |
| ESBC™ | MicroPak™ | STEALTH™ |  ™ |
|  Fairchild® | MicroPak2™ | SuperFET® | UHC® |
| Fairchild Semiconductor® | MillerDrive™ | SuperSOT™-3 | Ultra FRFET™ |
| FACT Quiet Series™ | MotionMax™ | SuperSOT™-6 | UniFET™ |
| FACT® | mWSaver™ | SuperSOT™-8 | VCX™ |
| FAST® | OptoHiT™ | SupreMOS® | VisualMax™ |
| FastvCore™ | OPTOLOGIC® | SyncFET™ | VoltagePlus™ |
| FETBench™ | OPTOPLANAR® | Sync-Lock™ | XS™ |
| FlashWriter®* |  SYSTEM GENERAL®* | | |
| FPS™ | | | |

* Trademarks of System General Corporation, used under license by Fairchild Semiconductor.

DISCLAIMER

FAIRCHILD SEMICONDUCTOR RESERVES THE RIGHT TO MAKE CHANGES WITHOUT FURTHER NOTICE TO ANY PRODUCTS HEREIN TO IMPROVE RELIABILITY, FUNCTION, OR DESIGN. FAIRCHILD DOES NOT ASSUME ANY LIABILITY ARISING OUT OF THE APPLICATION OR USE OF ANY PRODUCT OR CIRCUIT DESCRIBED HEREIN; NEITHER DOES IT CONVEY ANY LICENSE UNDER ITS PATENT RIGHTS, NOR THE RIGHTS OF OTHERS. THESE SPECIFICATIONS DO NOT EXPAND THE TERMS OF FAIRCHILD'S WORLDWIDE TERMS AND CONDITIONS, SPECIFICALLY THE WARRANTY THEREIN, WHICH COVERS THESE PRODUCTS.

LIFE SUPPORT POLICY

FAIRCHILD'S PRODUCTS ARE NOT AUTHORIZED FOR USE AS CRITICAL COMPONENTS IN LIFE SUPPORT DEVICES OR SYSTEMS WITHOUT THE EXPRESS WRITTEN APPROVAL OF FAIRCHILD SEMICONDUCTOR CORPORATION.

As used herein:

1. Life support devices or systems are devices or systems which, (a) are intended for surgical implant into the body or (b) support or sustain life, and (c) whose failure to perform when properly used in accordance with instructions for use provided in the labeling, can be reasonably expected to result in a significant injury of the user.
2. A critical component in any component of a life support, device, or system whose failure to perform can be reasonably expected to cause the failure of the life support device or system, or to affect its safety or effectiveness.

ANTI-COUNTERFEITING POLICY

Fairchild Semiconductor Corporation's Anti-Counterfeiting Policy. Fairchild's Anti-Counterfeiting Policy is also stated on our external website, www.fairchildsemi.com, under Sales Support.

Counterfeiting of semiconductor parts is a growing problem in the industry. All manufacturers of semiconductor products are experiencing counterfeiting of their parts. Customers who inadvertently purchase counterfeit parts experience many problems such as loss of brand reputation, substandard performance, failed applications, and increased cost of production and manufacturing delays. Fairchild is taking strong measures to protect ourselves and our customers from the proliferation of counterfeit parts. Fairchild strongly encourages customers to purchase Fairchild parts either directly from Fairchild or from Authorized Fairchild Distributors who are listed by country on our web page cited above. Products customers buy either from Fairchild directly or from Authorized Fairchild Distributors are genuine parts, have full traceability, meet Fairchild's quality standards for handling and storage and provide access to Fairchild's full range of up-to-date technical and product information. Fairchild and our Authorized Distributors will stand behind all warranties and will appropriately address any warranty issues that may arise. Fairchild will not provide any warranty coverage or other assistance for parts bought from Unauthorized Sources. Fairchild is committed to combat this global problem and encourage our customers to do their part in stopping this practice by buying direct or from authorized distributors.

PRODUCT STATUS DEFINITIONS

Definition of Terms

Datasheet Identification	Product Status	Definition
Advance Information	Formative / In Design	Datasheet contains the design specifications for product development. Specifications may change in any manner without notice.
Preliminary	First Production	Datasheet contains preliminary data; supplementary data will be published at a later date. Fairchild Semiconductor reserves the right to make changes at any time without notice to improve design.
No Identification Needed	Full Production	Datasheet contains final specifications. Fairchild Semiconductor reserves the right to make changes at any time without notice to improve the design.
Obsolete	Not In Production	Datasheet contains specifications on a product that is discontinued by Fairchild Semiconductor. The datasheet is for reference information only.

Rev. I62

ON Semiconductor and  are trademarks of Semiconductor Components Industries, LLC dba ON Semiconductor or its subsidiaries in the United States and/or other countries. ON Semiconductor owns the rights to a number of patents, trademarks, copyrights, trade secrets, and other intellectual property. A listing of ON Semiconductor's product/patent coverage may be accessed at www.onsemi.com/site/pdf/Patent-Marking.pdf. ON Semiconductor reserves the right to make changes without further notice to any products herein. ON Semiconductor makes no warranty, representation or guarantee regarding the suitability of its products for any particular purpose, nor does ON Semiconductor assume any liability arising out of the application or use of any product or circuit, and specifically disclaims any and all liability, including without limitation special, consequential or incidental damages. Buyer is responsible for its products and applications using ON Semiconductor products, including compliance with all laws, regulations and safety requirements or standards, regardless of any support or applications information provided by ON Semiconductor. "Typical" parameters which may be provided in ON Semiconductor data sheets and/or specifications can and do vary in different applications and actual performance may vary over time. All operating parameters, including "Typicals" must be validated for each customer application by customer's technical experts. ON Semiconductor does not convey any license under its patent rights nor the rights of others. ON Semiconductor products are not designed, intended, or authorized for use as a critical component in life support systems or any FDA Class 3 medical devices or medical devices with a same or similar classification in a foreign jurisdiction or any devices intended for implantation in the human body. Should Buyer purchase or use ON Semiconductor products for any such unintended or unauthorized application, Buyer shall indemnify and hold ON Semiconductor and its officers, employees, subsidiaries, affiliates, and distributors harmless against all claims, costs, damages, and expenses, and reasonable attorney fees arising out of, directly or indirectly, any claim of personal injury or death associated with such unintended or unauthorized use, even if such claim alleges that ON Semiconductor was negligent regarding the design or manufacture of the part. ON Semiconductor is an Equal Opportunity/Affirmative Action Employer. This literature is subject to all applicable copyright laws and is not for resale in any manner.

PUBLICATION ORDERING INFORMATION

LITERATURE FULFILLMENT:

Literature Distribution Center for ON Semiconductor
19521 E. 32nd Pkwy, Aurora, Colorado 80011 USA
Phone: 303-675-2175 or 800-344-3860 Toll Free USA/Canada
Fax: 303-675-2176 or 800-344-3867 Toll Free USA/Canada
Email: orderlit@onsemi.com

N. American Technical Support: 800-282-9855 Toll Free
USA/Canada
Europe, Middle East and Africa Technical Support:
Phone: 421 33 790 2910
Japan Customer Focus Center
Phone: 81-3-5817-1050

ON Semiconductor Website: www.onsemi.com
Order Literature: <http://www.onsemi.com/orderlit>
For additional information, please contact your local
Sales Representative