

THIS COPY IS PROVIDED ON A RESTRICTED BASIS AND IS NOT TO BE USED IN ANY WAY DETRIMENTAL TO THE INTERESTS OF PANDUIT CORP.

COVER

BASE

PANDUIT P/N	WEIGHT
T702EE	1.211 LBS [549.31 g]

△E  
△A

NOTES:

- SEE CURRENT CATALOG FOR ADDITIONAL PART SUFFIXES TO INDICATE COLOR AND PACKAGE QUANTITY.
- THIS PART IS INTENDED TO BE USED WITH PANDUIT TWIN 70 RACEWAY.
- DIMENSIONS IN PARENTHESES ARE IN METRIC.

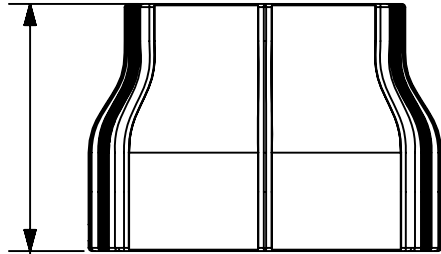

6.66 △G  
[169.1]

CONCENTRIC BREAKOUTS FOR CONDUIT SIZES: 1/2", 3/4", 1", 1 1/4", 1 1/2"

3.28 △G  
[83.3]

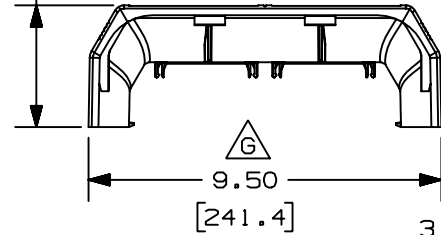

9.50 △G  
[241.4]

3.16  
[80.4]

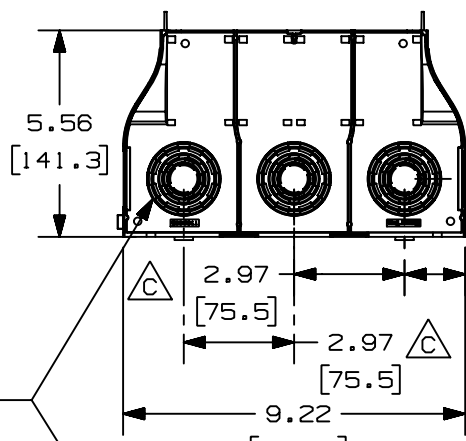

5.56  
[141.3]

1.56 △C  
[39.7]

△C

2.97  
[75.5]

2.97 △C  
[75.5]

1.63 △C  
[41.5]

9.22  
[234.1]

INSERT △D

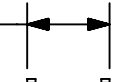

1.73  
[43.9]

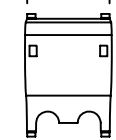

2.57  
[65.3]

COVER

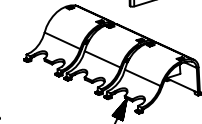
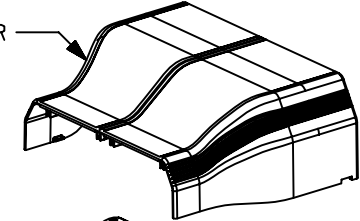

3 INSERTS △D

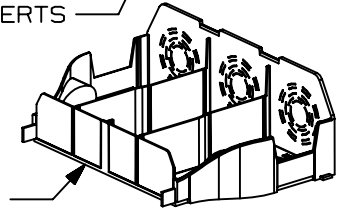

BASE

△C

2.97  
[75.5]

1.56 △C  
[39.7]

1.63 △C  
[41.5]

△C

2.97  
[75.5]

2.97 △C  
[75.5]

CAD FILENAME/LAYERS △F D34866DX\_DC\_T702EE\_03A.PRT

PANDUIT CORP. TINLEY PARK, ILLINOIS

T702 ENTRANCE END FITTING (T702EE) CUSTOMER DRAWING

UNLESS OTHERWISE SPECIFIED, DIMENSIONAL TOLERANCES ARE:  
(.X) ± (.XXX) ±  
(.XX) ±.03(.8) ANGLES ±

UNLESS OTHERWISE SPECIFIED, ALL DIMENSIONS ARE GIVEN IN INCHES, THIRD ANGLE PROJECTION.

DRAWN BY DW  
DATE 02-27-98  
CHECKED BY HIW  
MAT'L: PVC  
△A

SCALE NONE  
DRAWING NO. 34866-71  
DWG SIZE A

REV	DATE	BY	CHK	DESCRIPTION	ECN	CHK	CUST	SUP
-	-----	---	--	H. REVISED PART DESCRIPTION: T702 ENTRANCE END FITTING WAS TWIN 70 ENTRANCE END	-----	-----	-----	
-	-----	---	--	G. ADDED DIMENSIONS F. REVISED CAD FILE NAME	-----	-----	-----	
3	08-13-04	JBN	PM	E. REVISED WEIGHT INFORMATION D. ADDED BEND RADIUS INSERTS	34866-71	RGRO	RGRO	
2	03-15-00	JHNU	BKR	C. ADDED DIMENSIONS FOR BREAKOUTS	34866-71	HIW	HIW	
1	07-27-99	DW	HIW	B. REVISED TITLE NAME A. MAT'L WAS ABS/PC AND REVISED WEIGHT	34866-71	HIW	HIW	
R	02-27-98	DW	HIW	RELEASED TO PRODUCTION	34866-71	HIW	HIW	