



# Smart Socket

# User Guide

FPGA-UG-02046 Version 1.1

April 2018

## Contents

1. Introduction .....	4
2. Features .....	4
3. Block Diagram .....	5
4. Board Specifications .....	6
5. Software Requirements .....	7
5.1. Generic Programming .....	7
5.2. Specific Software Requirements for Certain Device Families .....	11
5.2.1. MachXO3 Device Family Programming .....	11
5.2.2. ECP5 Device Family Programming .....	11
5.2.3. L-ASC10 Device Programming .....	11
5.2.4. iCE40 Device Family Programming .....	16
5.2.5. CrossLink Device Family Programming .....	19
6. Ordering Information .....	21
Technical Support .....	22
Appendix A. Smart Socket Board Schematics .....	23
Appendix B. Debugging .....	27
Revision History .....	29

## Figures

Figure 3.1. Smart Socket Programming Board Block Diagram.....	5
Figure 5.1. Getting Started .....	7
Figure 5.2. Scanning.....	7
Figure 5.3. Unable to Identify Device .....	8
Figure 5.4. Identifying Correct Device .....	8
Figure 5.5. Access Device Properties through Edit .....	8
Figure 5.6. Programming Options.....	9
Figure 5.7. Bit File Selection .....	9
Figure 5.8. Program Icon .....	9
Figure 5.9. Design Menu.....	9
Figure 5.10. Programming in Progress.....	10
Figure 5.11. Successful Programming.....	10
Figure 5.12. ASC Socket – Scanned MachXO2 Device .....	11
Figure 5.13. ASC Socket – Operation .....	11
Figure 5.14. ASC Socket – Device Properties .....	12
Figure 5.15. ASC Socket – Add External ASC Device .....	12
Figure 5.16. ASC Socket – ASC File Load Menu.....	13
Figure 5.17. ASC Socket – Operation Menu.....	14
Figure 5.18. Warning .....	14
Figure 5.19. ASC Socket – Warning for MachXO2 .....	15
Figure 5.20. ASC Socket – Ready to Program Step .....	15
Figure 5.21. ASC Socket – Programming.....	15
Figure 5.22. ASC Socket – Programming Completed .....	16
Figure 5.23. iCE40 Family – Scanning Failed .....	16
Figure 5.24. iCE40 Family – Device Family List .....	17
Figure 5.25. iCE40 Family – Select the Programming File.....	17
Figure 5.26. iCE40 Family – Program Icon .....	17
Figure 5.27. iCE40 Family – Programming Completed Successfully .....	18
Figure 5.28. CrossLink Family – Scanning Failed .....	19
Figure 5.29. CrossLink Family – Device Family List .....	20
Figure 5.30. CrossLink Family – Select the Programming File .....	20
Figure 5.31. CrossLink Family – Program Icon .....	21
Figure 5.32. CrossLink Family – Programming Completed Successfully .....	21
Figure A.1. USB Programming Interface .....	23
Figure A.2. Voltage Regulator and LEDs .....	24
Figure A.3. JTAG Bank and Connections .....	25
Figure A.4. VCC Core, Bypass Caps, and Test Points .....	26
Figure B.1. Failed to Scan Device .....	27
Figure B.2. Detect Cable (FTDI).....	27
Figure B.3. Scanning Completed.....	28

## 1. Introduction

This document describes Smart Socket, the next generation programming solution, from Lattice Semiconductor. Smart Socket replaces the legacy Lattice Model 300 and its associated Socket Adapters. Smart Socket uses the same JTAG-based Lattice Diamond<sup>®</sup> Programmer programming software that is used with Lattice Semiconductor's popular evaluation and customer boards. Standard ESD environment and procedures should be followed when working with loose devices and the Smart Socket.

## 2. Features

Each Smart Socket board is unique for a device family and package. Smart Socket boards have common features such as:

- Powered over simple USB cable
- Power switch to remove power from the socket
- Integrated FTDI USB interface to work directly with Lattice Programming tools
- Power indicator LEDs
- Convenient test points

### 3. Block Diagram

Figure 3.1 shows the high level blocks of a Smart Socket board. The four major blocks on the board are:

- USB connector
- USB-to-SPI/JTAG communication bridge
- Board power regulator
  - Some product families, such as MachX02, have parts with different core supply voltage requirements. The Smart Socket board jumper (J2) allows you to select between 1.2 V and 3.3 V core supply voltage. The selected core supply voltage is indicated by LEDs located next to the jumper on the board.
- Lattice Semiconductor Socket (family specific)

A switch controls power to the socket. Three separate LEDs indicate USB power, Socket Power and Programming Done (Programming Done support varies by device family).

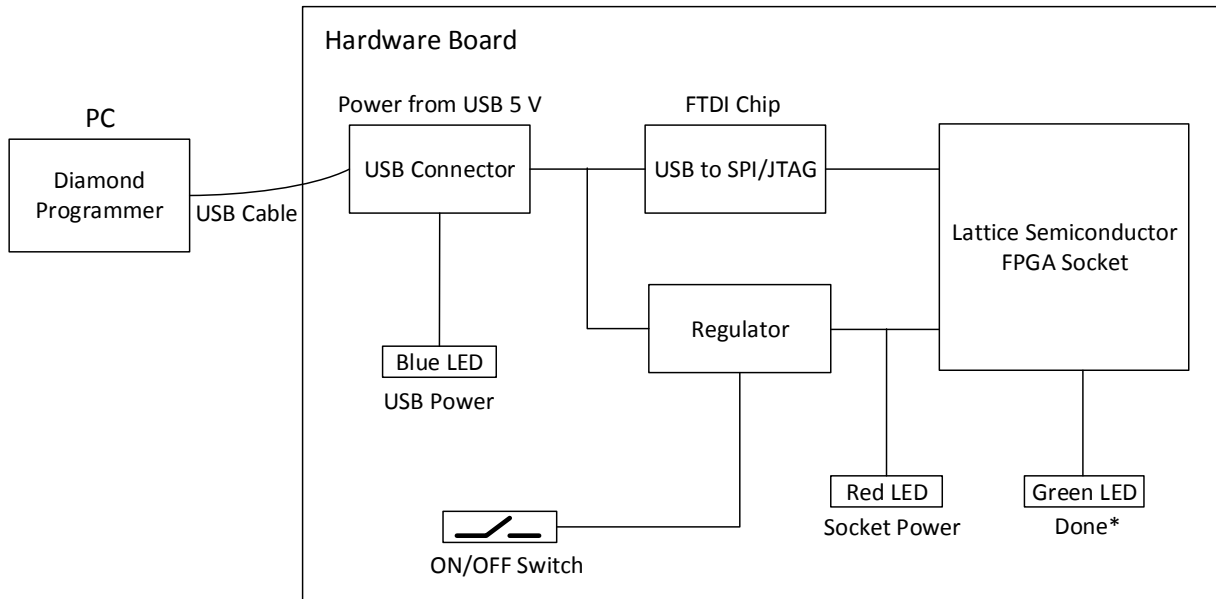

\*Note: Programming Done support depends on the device family.

**Figure 3.1. Smart Socket Programming Board Block Diagram**

## 4. Board Specifications

The outline dimension is the same for all Smart Socket boards. The dimensions of the socket vary based on target device family and package.

Board dimensions:

- Width: 4 inch
- Length: 6 inch
- Height: < 2 inch

Electrical Specification:

- +5 V @ 500 mA or less (provided by USB cable)

The complete list of sockets is available at: <http://www.latticesemi.com/sockets>

## 5. Software Requirements

Smart Socket is supported by Lattice Diamond® Programmer. The latest version of the Lattice Diamond Programmer can be downloaded at:

<http://www.latticesemi.com/en/Products/DesignSoftwareAndIP/FPGAandLDS/LatticeDiamond.aspx>

Smart Socket works with the Lattice Diamond Programmer using only a USB cable. Connect the cable from the Smart Socket to a PC, and use the cable search feature in Lattice Diamond Programmer to establish the programming link. The steps to program a device are described below.

### 5.1. Generic Programming

To program the device:

1. Launch the Lattice Diamond Programmer software. The **Diamond Programmer Getting Started** dialog box appears as shown in [Figure 5.1](#).

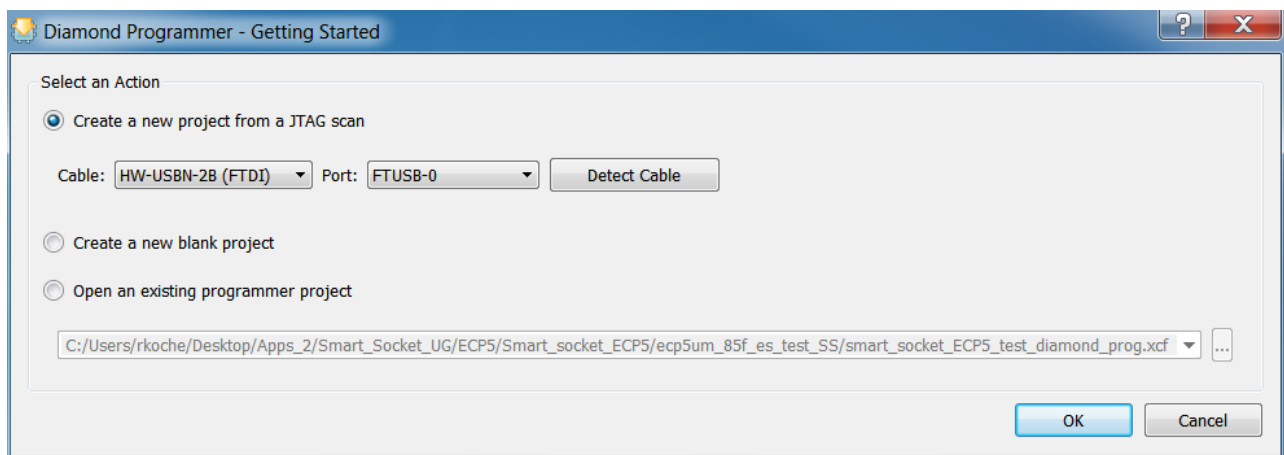

**Figure 5.1. Getting Started**

2. Click **OK**. The Diamond Programmer automatically starts scanning. The scanning page appears as shown in [Figure 5.2](#).

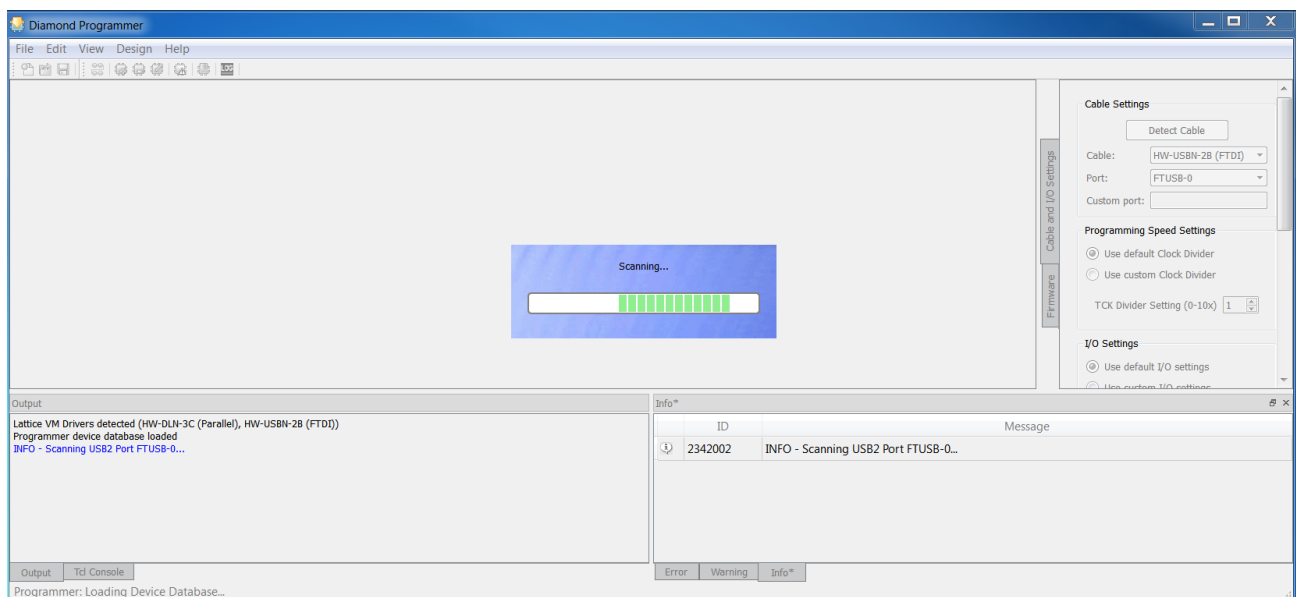

**Figure 5.2. Scanning**

When the device scanning is completed, the Diamond Programmer tool shows the device present in socket in the **Device** tab. If the Diamond Programmer is unable to identify the device in socket, the device family name is highlighted with a yellow background under **Device** as shown in Figure 5.3. Some device families may not support the scan operation. For details, see the [Software Requirements for Specific Device Families](#) section.

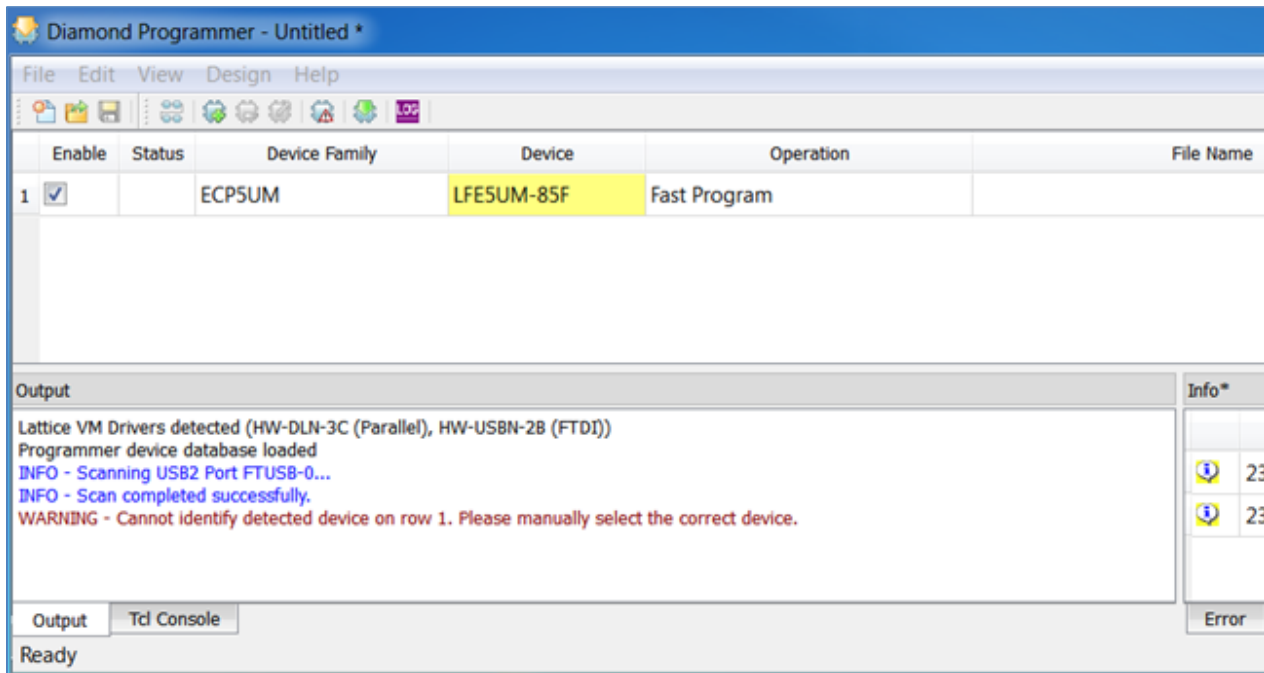

**Figure 5.3. Unable to Identify Device**

In such case, click in the yellow highlighted area and select the appropriate device by matching the device name on the package with the dropdown list in the **Device** tab. Select the correct device on the dropdown list, and the yellow background highlighting disappears as shown in Figure 5.4.

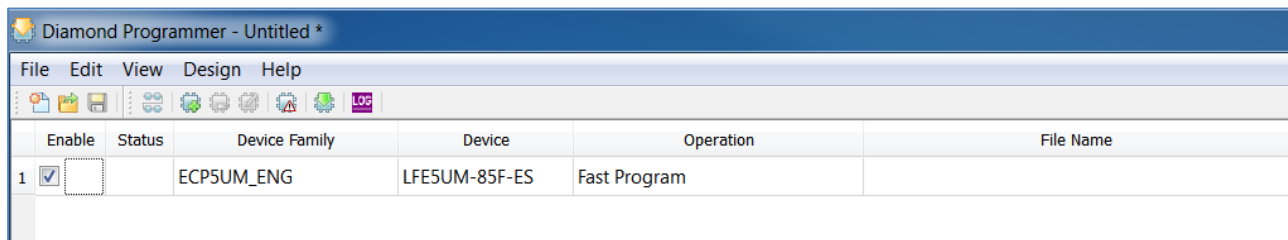

**Figure 5.4. Identifying Correct Device**

- Verify that the desired **Operation** is specified, and update if necessary. To update the operation, select the device row so that it is highlighted in blue as shown in Figure 5.5. On the menu bar, click **Edit**, and on the dropdown menu click **Device Properties** as shown in Figure 5.5.

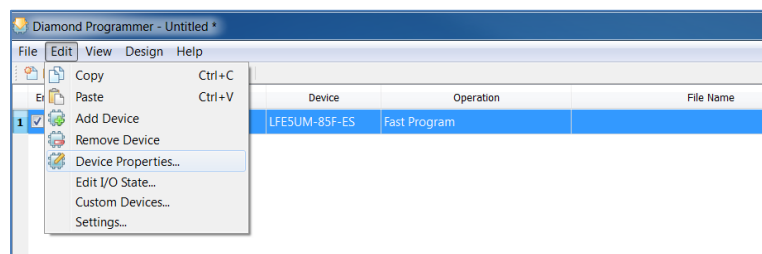

**Figure 5.5. Access Device Properties through Edit**



- Select the appropriate programming file by clicking the **Browse** button  in the **Programming Options** section as shown in [Figure 5.6](#).
- Click **OK**.

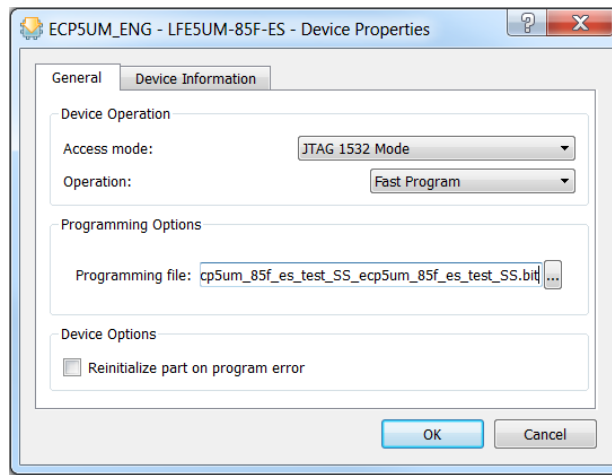

**Figure 5.6. Programming Options**

- The selected file is shown under **File Name** in the Diamond Programmer main interface as shown in [Figure 5.7](#).

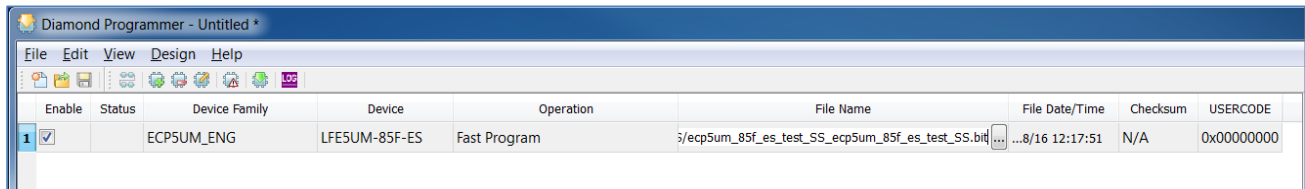

**Figure 5.7. Bit File Selection**

- To start programming the device, click the **Program** icon  shown in [Figure 5.8](#).

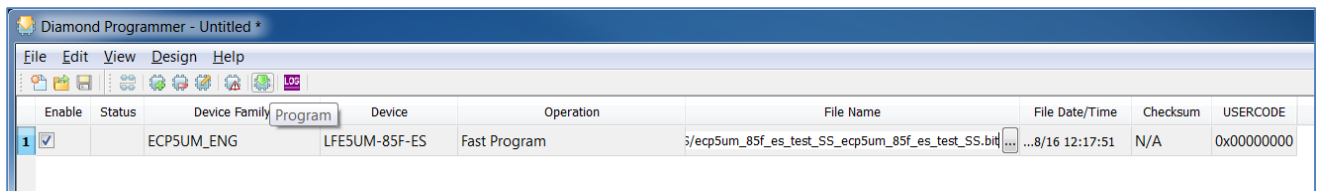

**Figure 5.8. Program Icon**

You can also click **Design** and select **Program** as shown in [Figure 5.9](#).

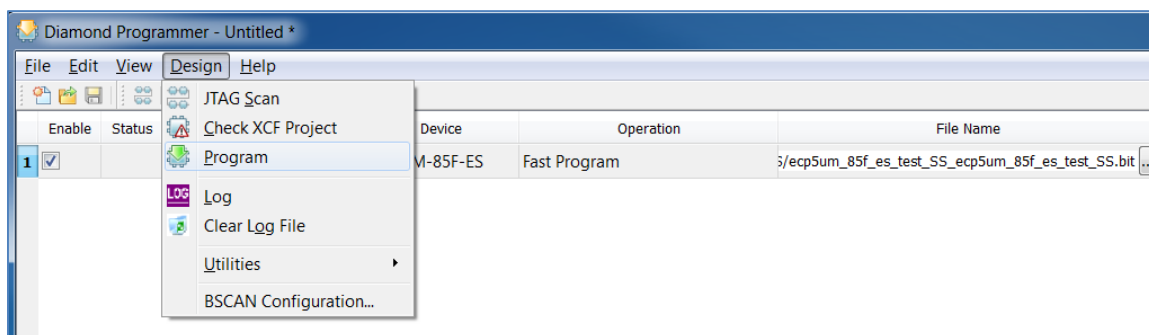

**Figure 5.9. Design Menu**

Figure 5.10 shows that the programming of device is in progress.

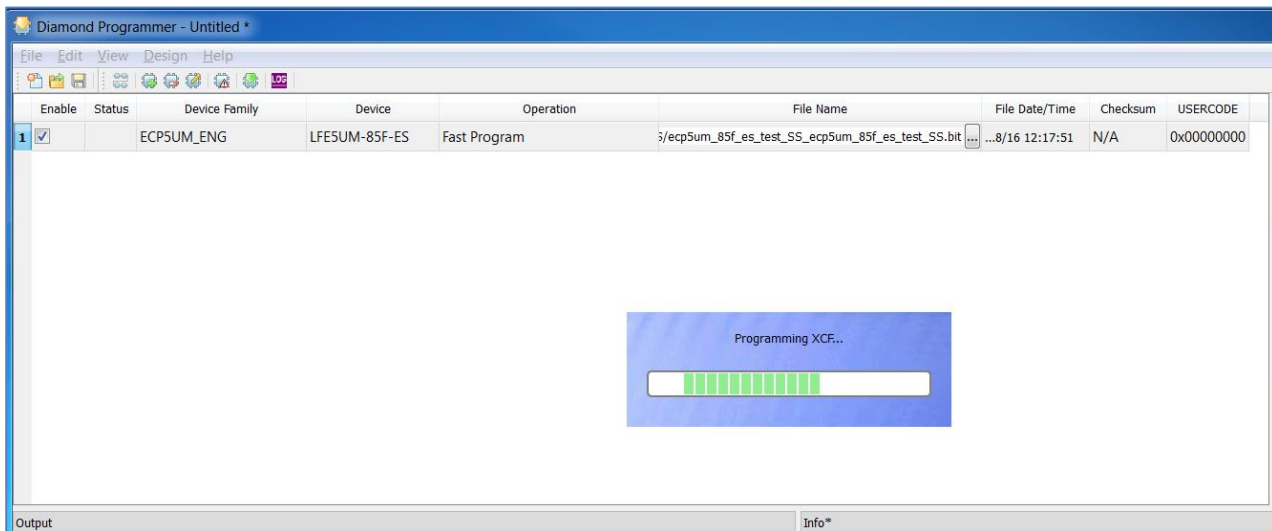

Figure 5.10. Programming in Progress

- When the programming of the device is completed, the **Status** option changes to **PASS** and **Operation: successful** message appears in the **Output** console as shown in Figure 5.11.

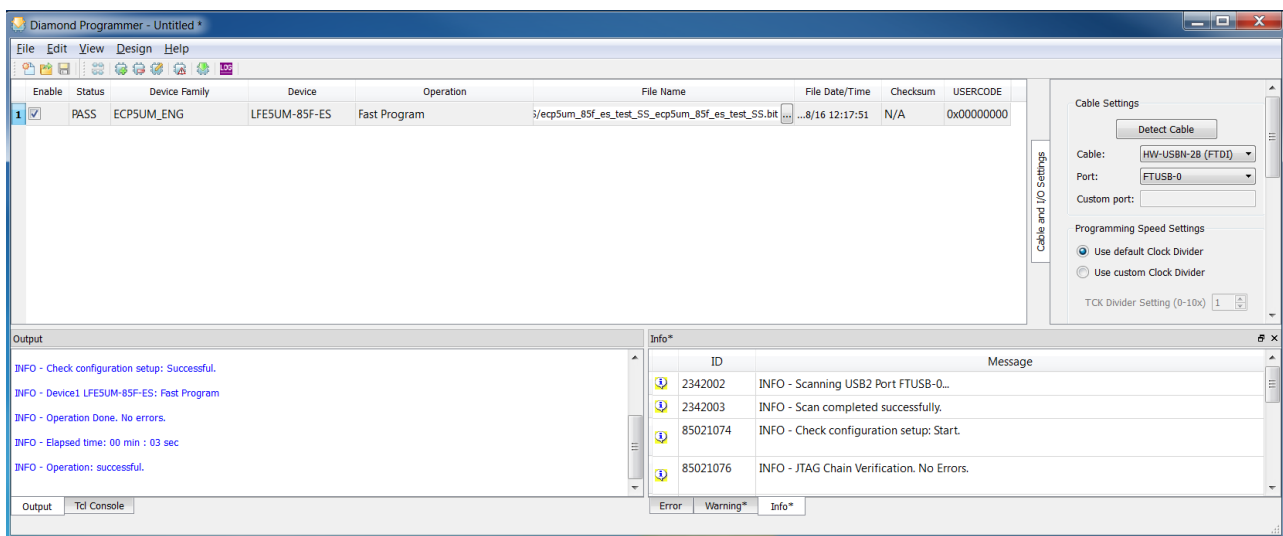

Figure 5.11. Successful Programming

On the board, the green *Done* LED is lit when the device is successfully programmed (*Done* LED behavior is device dependent, see the [Software Requirements for Specific Device Families](#) section for details).

## 5.2. Software Requirements for Specific Device Families

### 5.2.1. MachXO3 Device Family Programming

The programming of MachXO3 device family follows steps similar to the process described in the [Generic Programming](#) section. *Done* is not a dedicated output in the MachXO3 device family. *Done* LED indication is not supported.

### 5.2.2. ECP5 Device Family Programming

The programming of ECP5 device family follows steps similar to the process described in the [Generic Programming](#) section. When the programming of these devices is completed successfully, the *Done* LED is lit.

### 5.2.3. L-ASC10 Device Programming

To program the ASC device:

1. Launch the Lattice Diamond Programmer software.

The Diamond Programmer automatically starts scanning the device and detects the MachXO2 device as shown in [Figure 5.12](#).

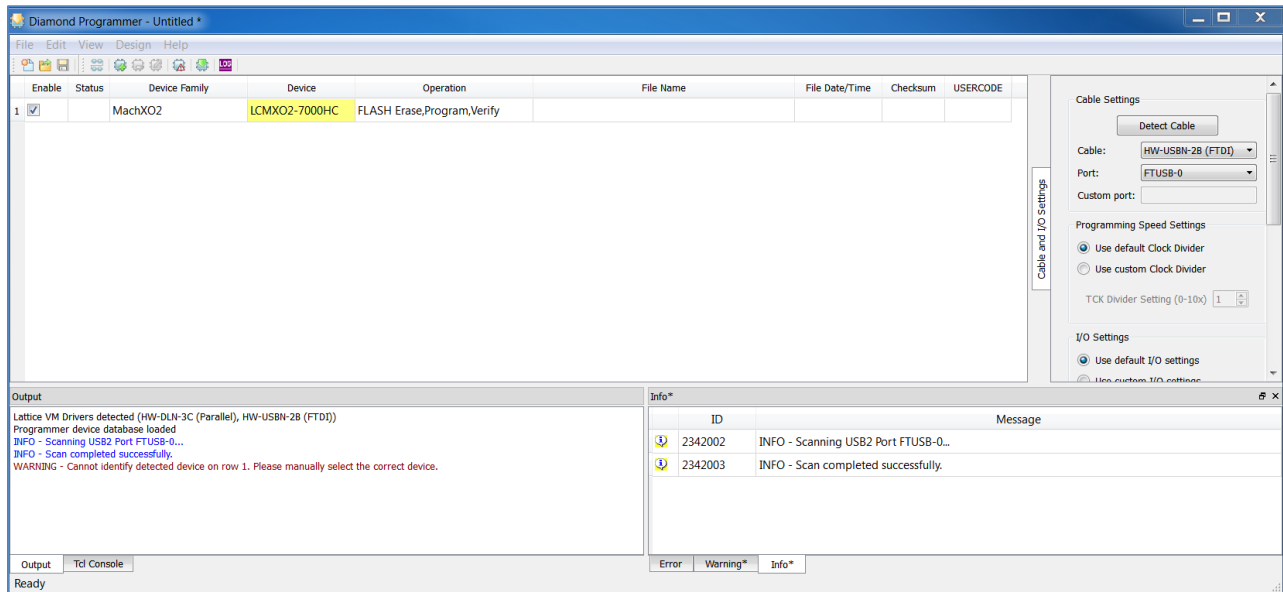

Figure 5.12. ASC Socket – Scanned MachXO2 Device

2. Double click in the box under **Operation** as shown in [Figure 5.13](#).

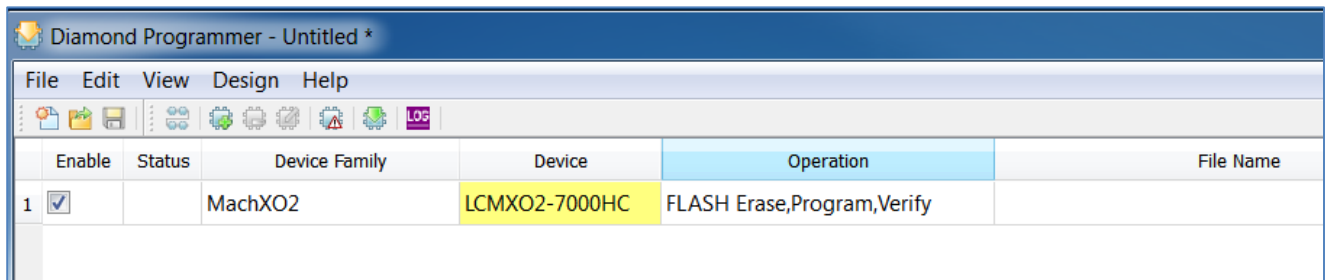

Figure 5.13. ASC Socket – Operation

3. The **Device Properties** dialog box appears as shown in [Figure 5.14](#). In the **Access Mode** dropdown list, select **PTM Programming**. Note that in the main interface, **PTM Bypass** is indicated under **Operation**.

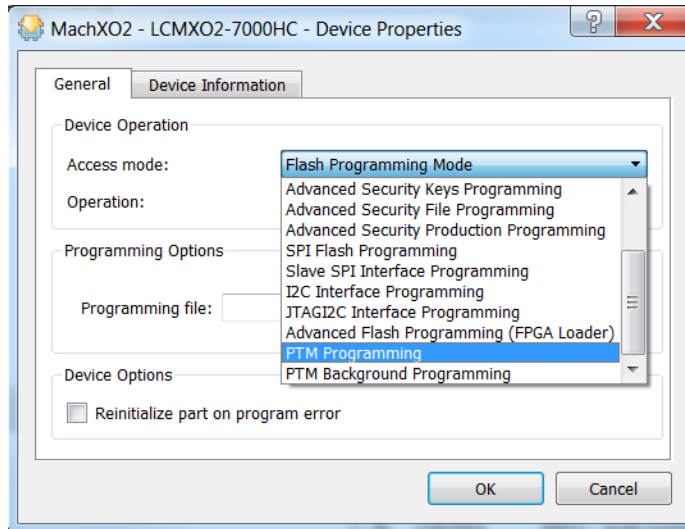



Figure 5.14. ASC Socket – Device Properties

4. Add an external ASC device, by clicking the  button as shown in Figure 5.15. The **Device Properties** dialog box appears as shown in Figure 5.16.

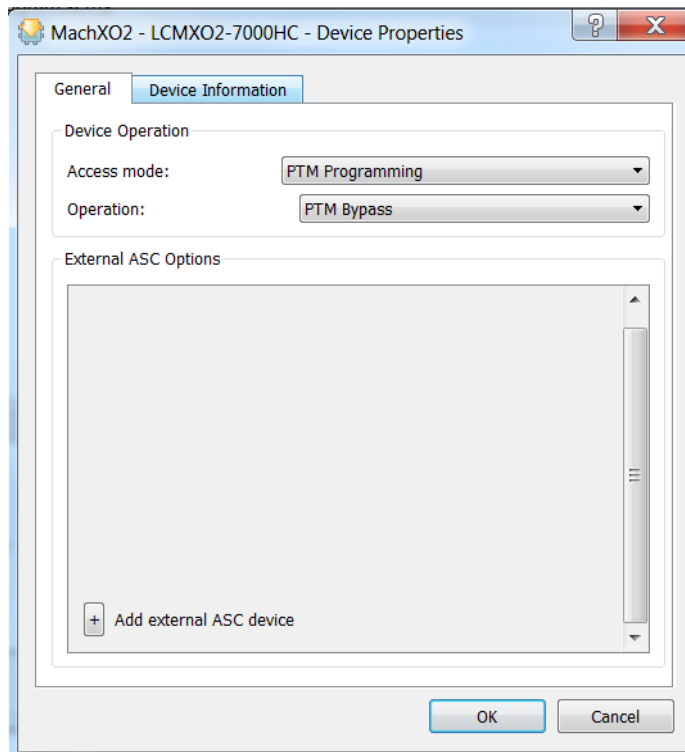
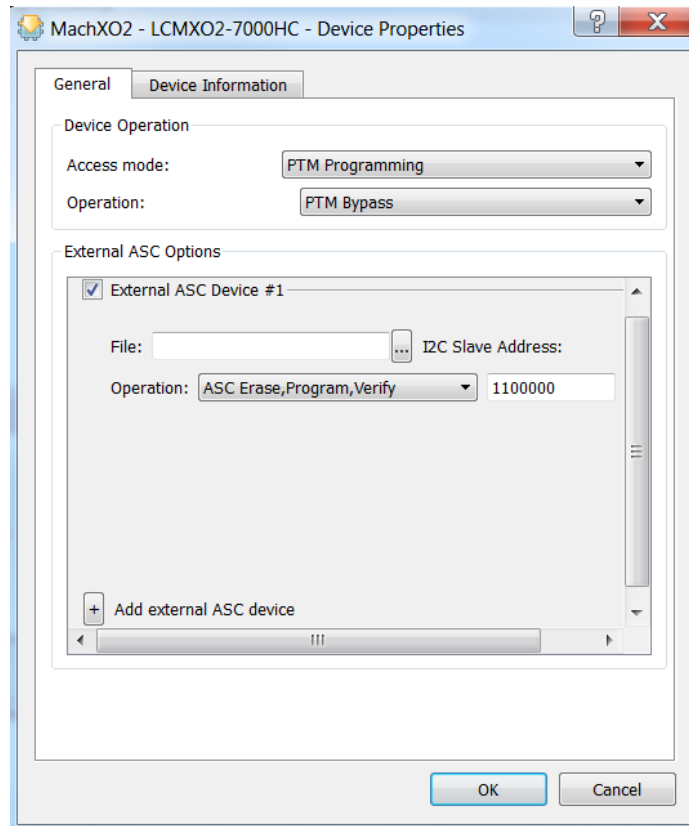



Figure 5.15. ASC Socket – Add External ASC Device



**Figure 5.16. ASC Socket – ASC File Load Menu**

5. Select the programming file by clicking the **Browse** button . In the **Device Properties** dialog box, select the \*ASCx.hex file.
6. From the **Operation** dropdown list, select **ASC Erase, Program, Verify**.

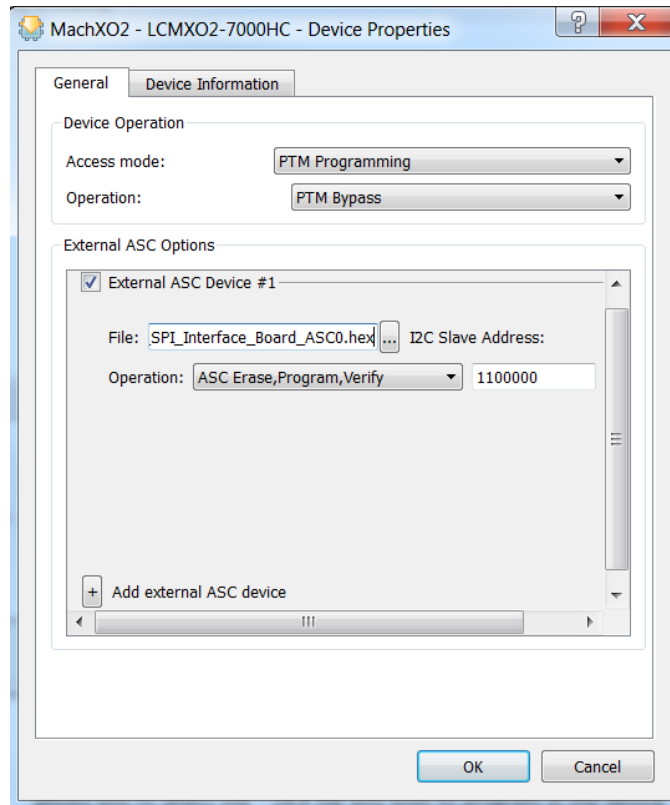

Figure 5.17. ASC Socket – Operation Menu

The warning shown in Figure 5.18 may appear if the selected external ASC device and the File targeting device do not match.

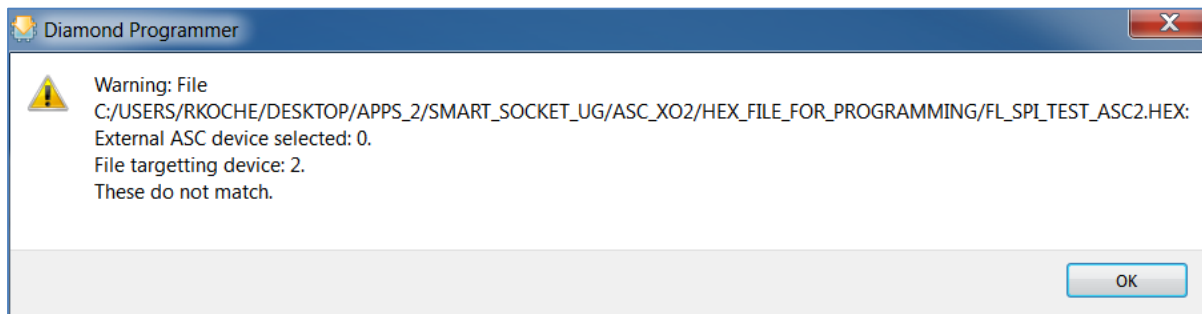
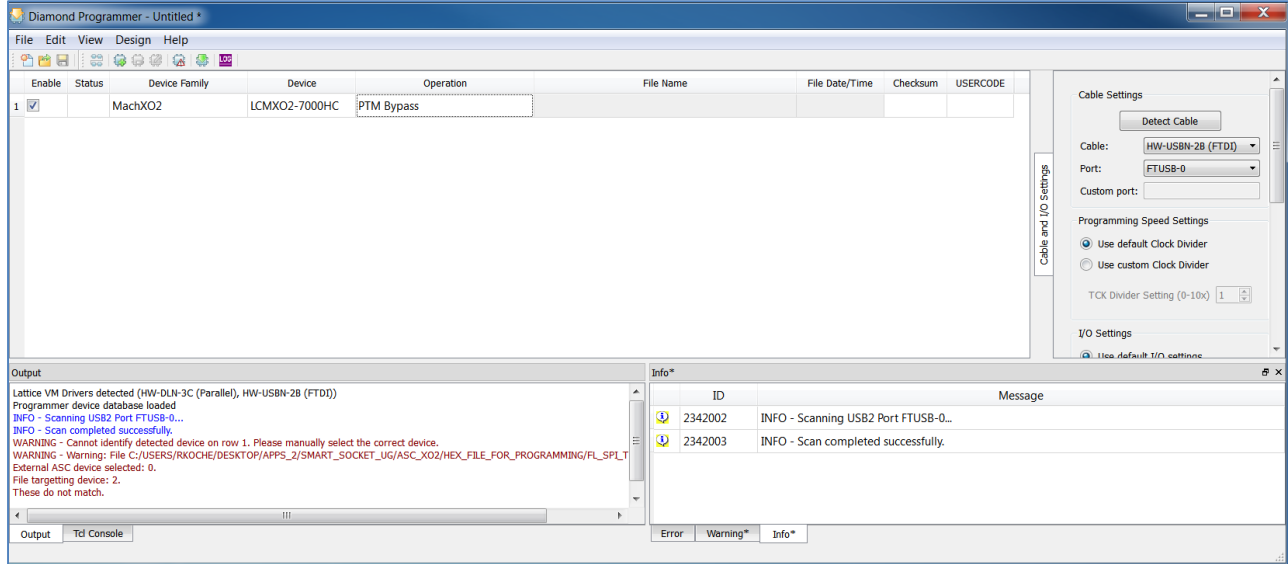

Figure 5.18. Warning

7. Click **OK**. The same warning appears in the output console window as shown Figure 5.19.



**Figure 5.19. ASC Socket – Warning for MachXO2**

Under **Operation**, **PTM Bypass** is indicated. The **File Name** field is greyed out (to prevent adding a new file) as shown in [Figure 5.20](#).

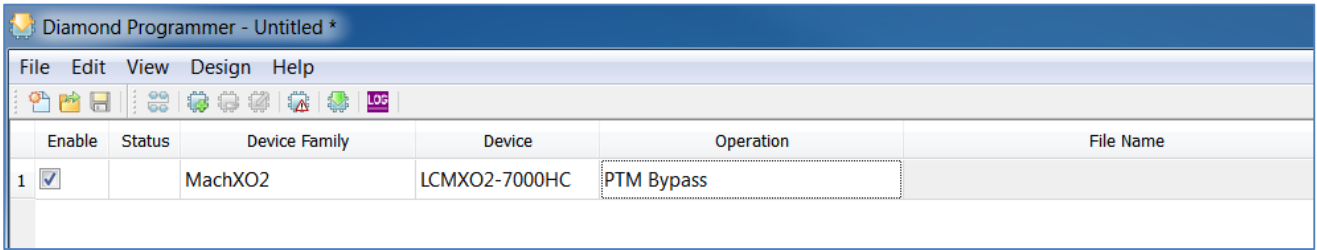

**Figure 5.20. ASC Socket – Ready to Program Step**

8. Program the ASC device through the MachXO2 device on the Smart Socket board by clicking the **Program** icon  as shown in [Figure 5.21](#).

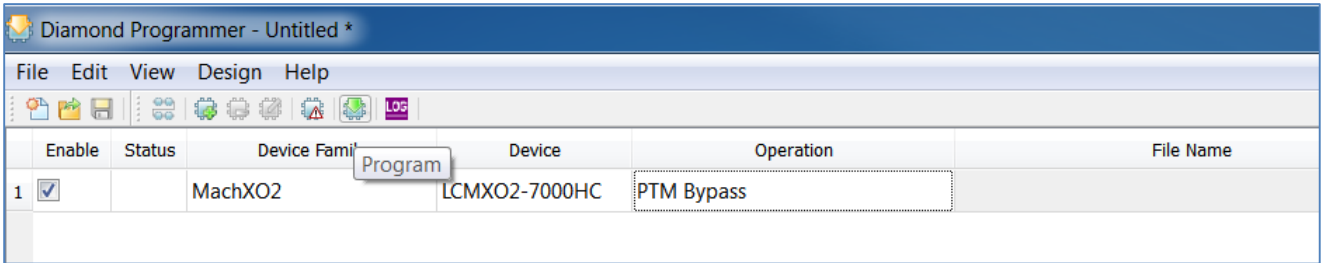

**Figure 5.21. ASC Socket – Programming**

9. When the programming of the device is completed, the **Status** option changes to **PASS** and **Operation: successful** message appears in the **Output** console as shown in [Figure 5.22](#). During the programming activity the MXO2\_SDA and MXO2\_SCL LED light blink on the board showing communication between the MachXO2 and ASC devices. *Done* is not a dedicated output in the MachXO2 family. *Done* LED indication is not supported.

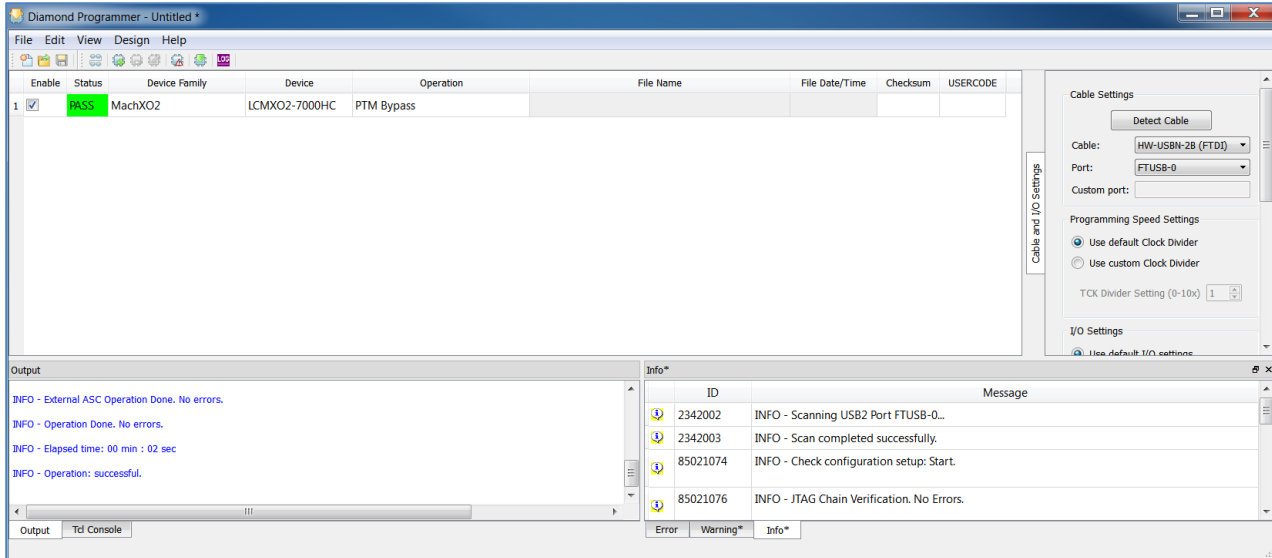

Figure 5.22. ASC Socket – Programming Completed

### 5.2.4. iCE40 Device Family Programming

To program the iCE40 device:

1. Launch the Lattice Diamond Programmer software.

The scanning of the device fails because the Scan operation is supported over JTAG interface only, and the iCE40 family of devices uses SPI interface for programming. See [Figure 5.23](#).

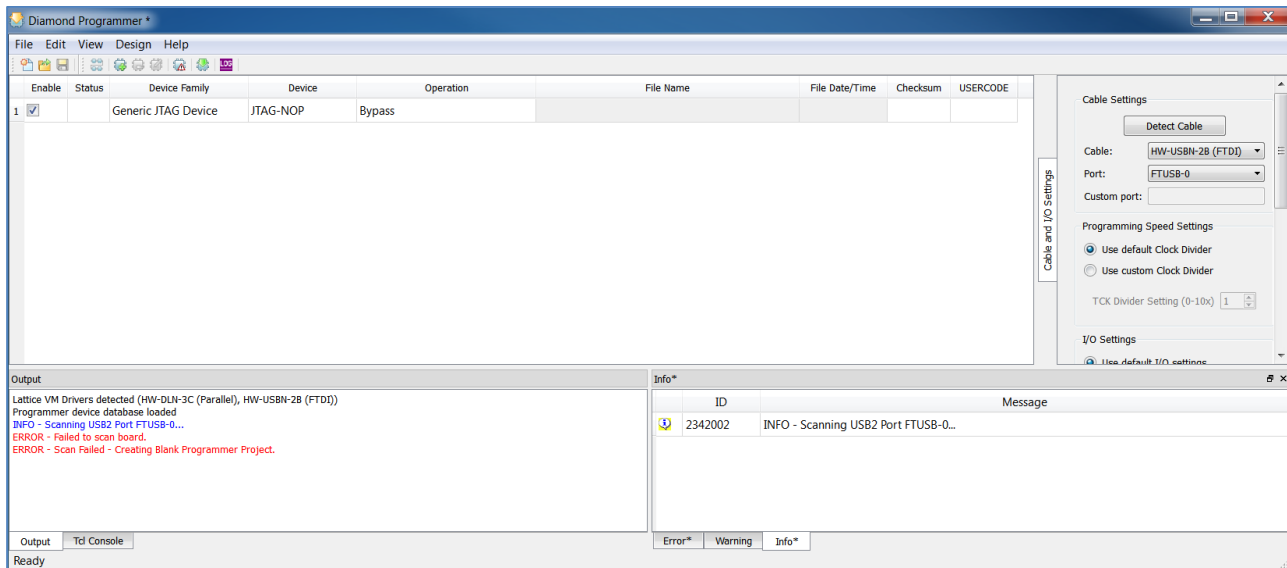
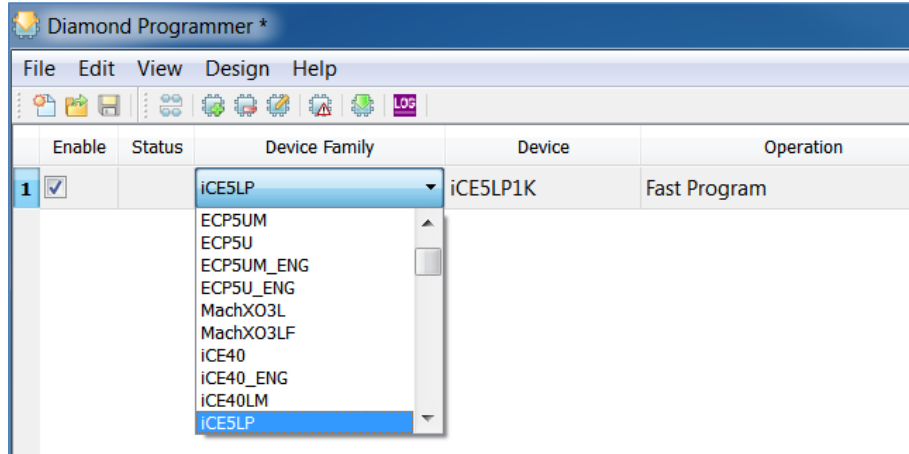



Figure 5.23. iCE40 Family – Scanning Failed

2. Manually select the device by choosing the following options as shown in [Figure 5.24](#).
  - **Device Family:** iCE5LP (select the appropriate device from the dropdown list)
  - **Device:** iCE5LP1K (choose the size of the device based on the device present in the socket)





**Figure 5.24. iCE40 Family – Device Family List**

3. Select the programming file to program the iCE40 device by double clicking the **Browse** button  under **File Name** as shown in [Figure 5.25](#).

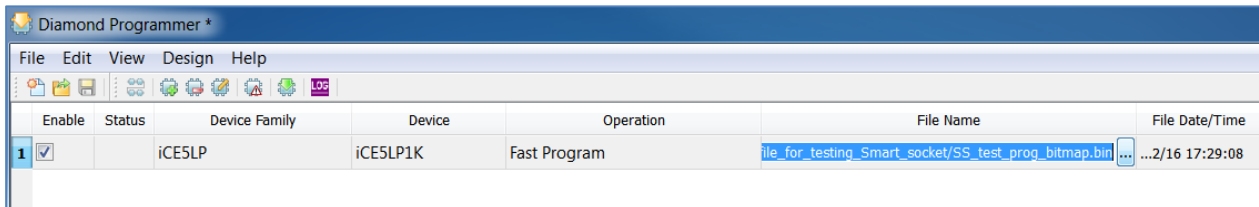

**Figure 5.25. iCE40 Family – Select the Programming File**

4. Click the **Program** icon  to program the device as shown in [Figure 5.26](#).

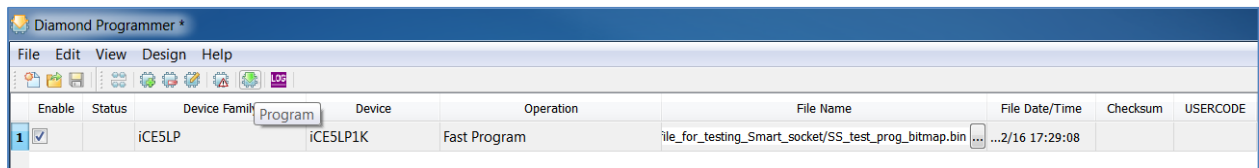

**Figure 5.26. iCE40 Family – Program Icon**

5. When the programming of the device is completed, the **Status** option changes to **PASS** and **Operation: successful** message appears in the **Output** console as shown in [Figure 5.27](#).

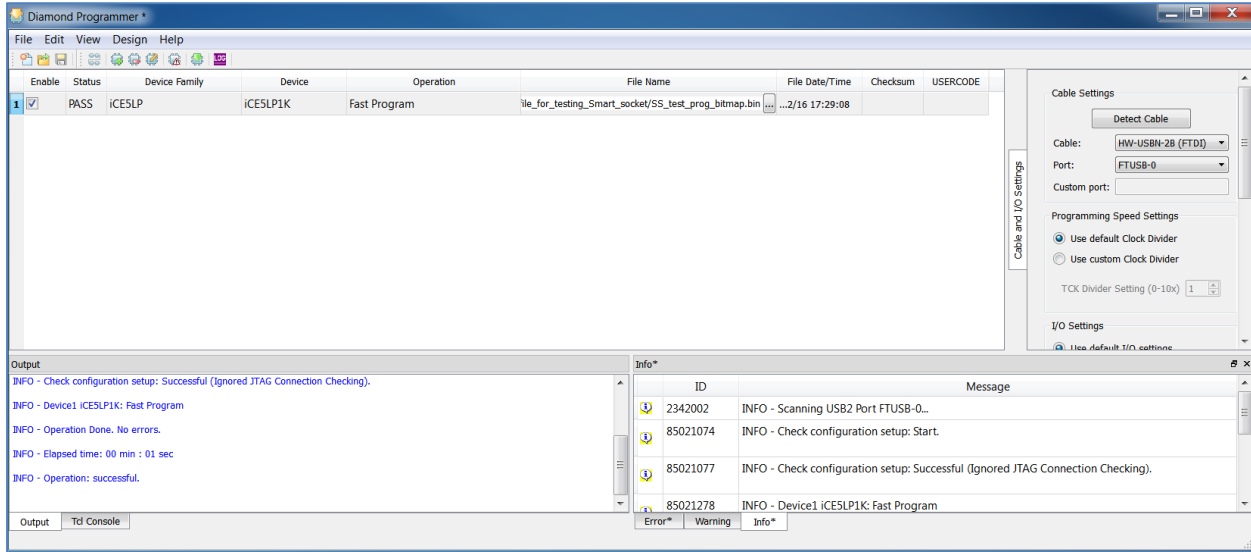

**Figure 5.27. iCE40 Family – Programming Completed Successfully**

## 5.2.5. CrossLink Device Family Programming

To program the CrossLink Device:

1. Launch the Lattice Diamond Programmer software.

The scanning of the device fails as the Scan operation is supported over JTAG interface only, and the CrossLink family of devices uses SPI interface for programming. See [Figure 5.28](#).

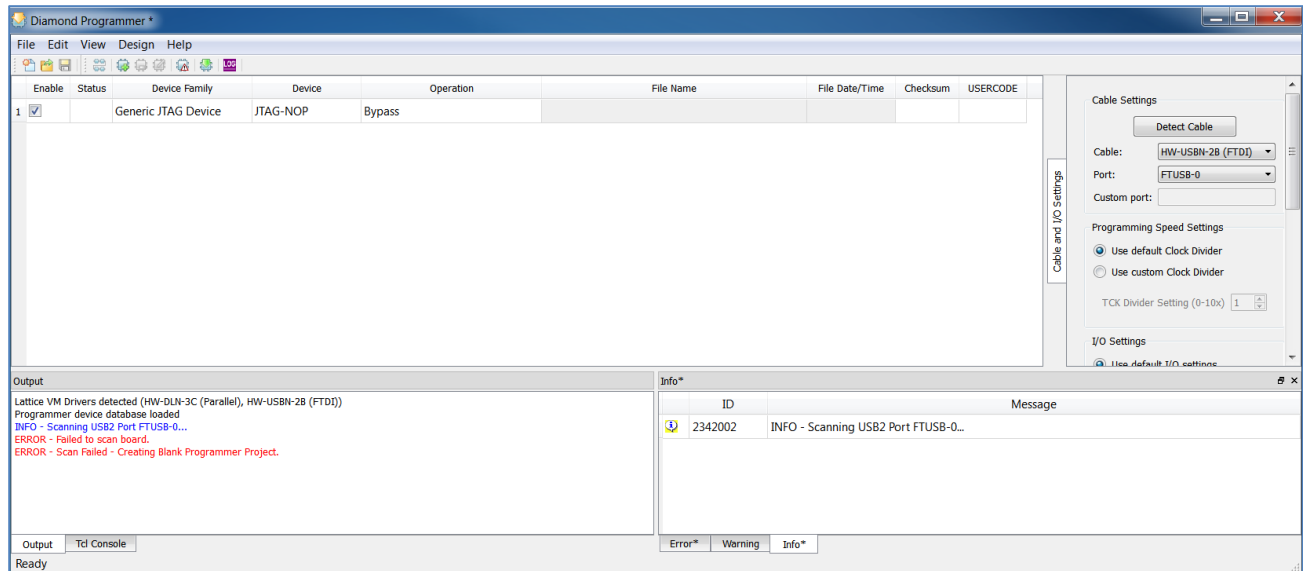

**Figure 5.28. CrossLink Family – Scanning Failed**

2. Manually select the device by choosing the following options as shown in [Figure 5.29](#).
  - **Device Family:** LIFMD (select the appropriate device from the dropdown list)
  - **Device:** LIF-MD6000 or LIA-MD6000 (choose between industrial or automotive grade of CrossLink based on the device present in the socket)

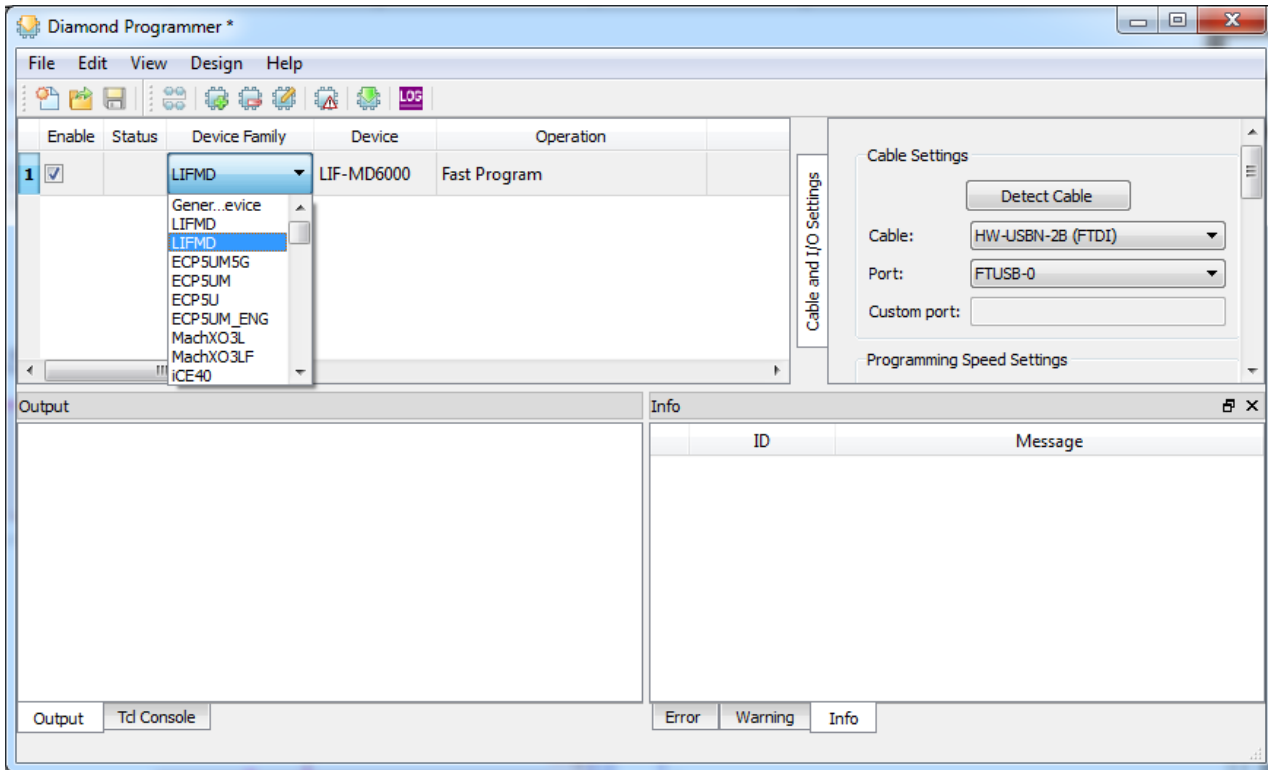



Figure 5.29. CrossLink Family – Device Family List

3. Select the programming file that you want to program in the CrossLink device by double clicking the **Browse** button  under **File Name** as shown in Figure 5.30.

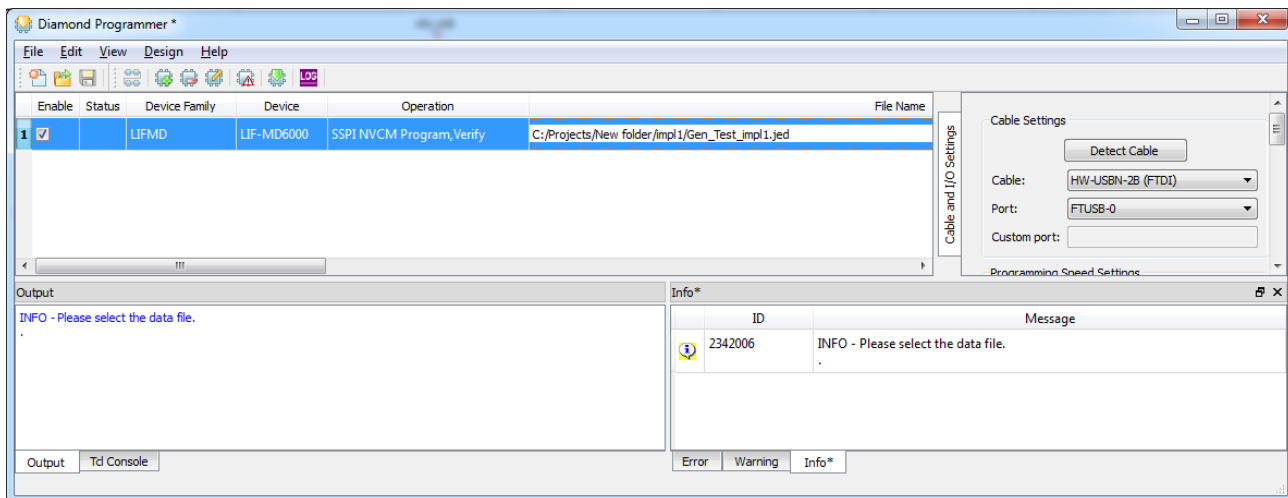
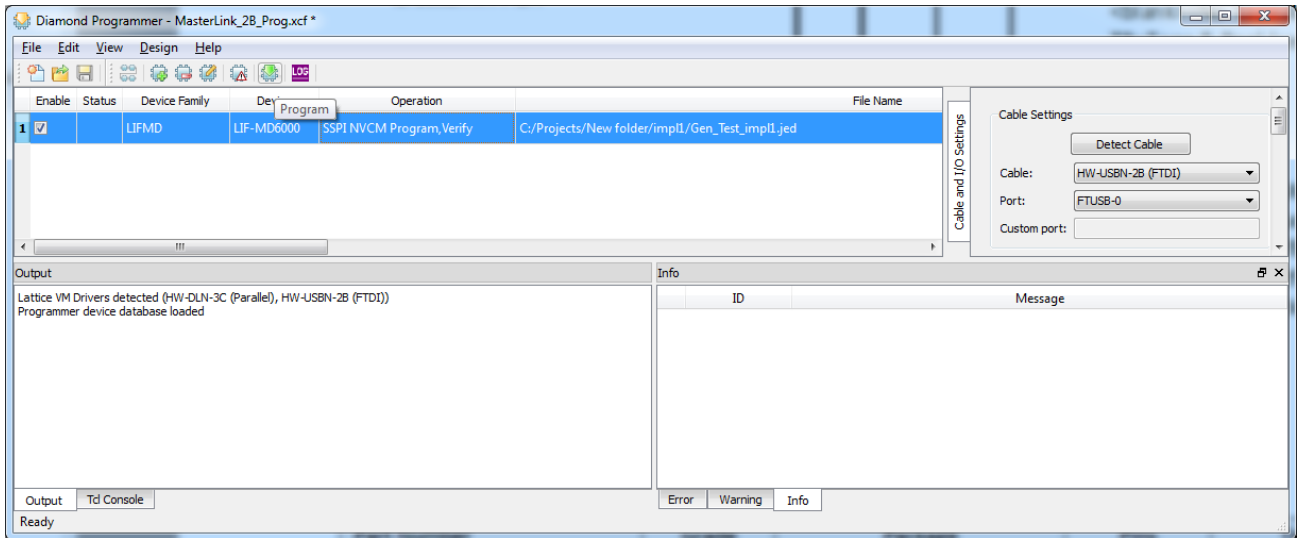

Figure 5.30. CrossLink Family – Select the Programming File

4. Click the **Program** icon  to program the device as shown in Figure 5.31.



**Figure 5.31. CrossLink Family – Program Icon**

- When the programming of the device is completed, the **Status** option changes to **PASS** and **Operation: successful** message appears in the **Output** console as shown in [Figure 5.32](#).

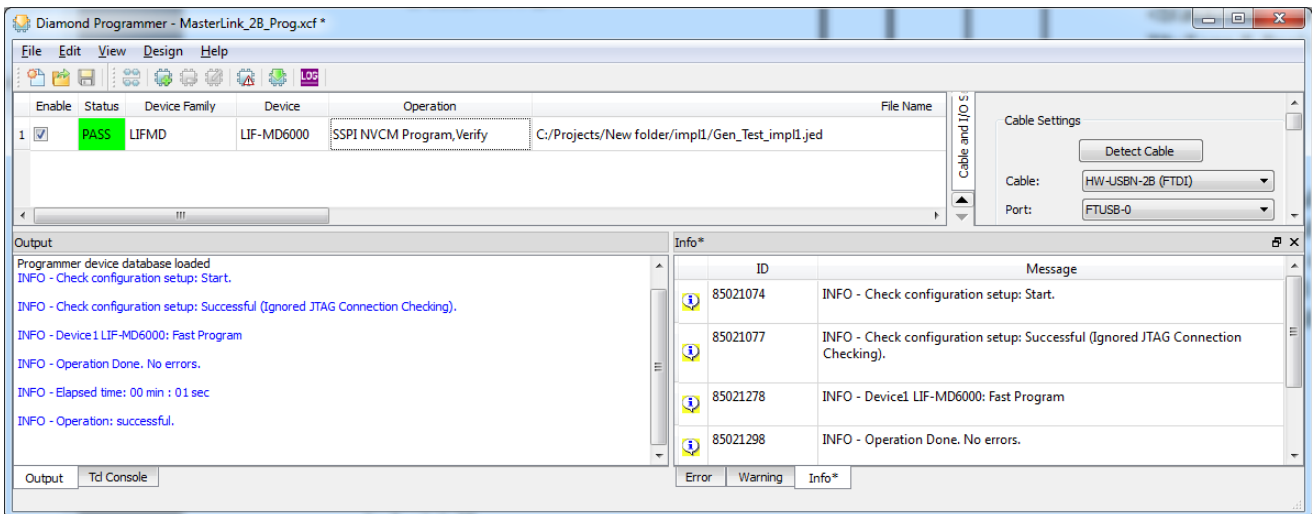

**Figure 5.32. CrossLink Family – Programming Completed Successfully**

## 6. Ordering Information

Ordering part numbers for a particular socket are available at <http://www.latticesemi.com/sockets>

## Technical Support

For assistance, submit a technical support case at [www.latticesemi.com/techsupport](http://www.latticesemi.com/techsupport)

# Appendix A. Smart Socket Board Schematics

The following are representative schematics of a Smart Socket board. The FTDI and voltage regulator portions are the same across various Smart Socket boards.

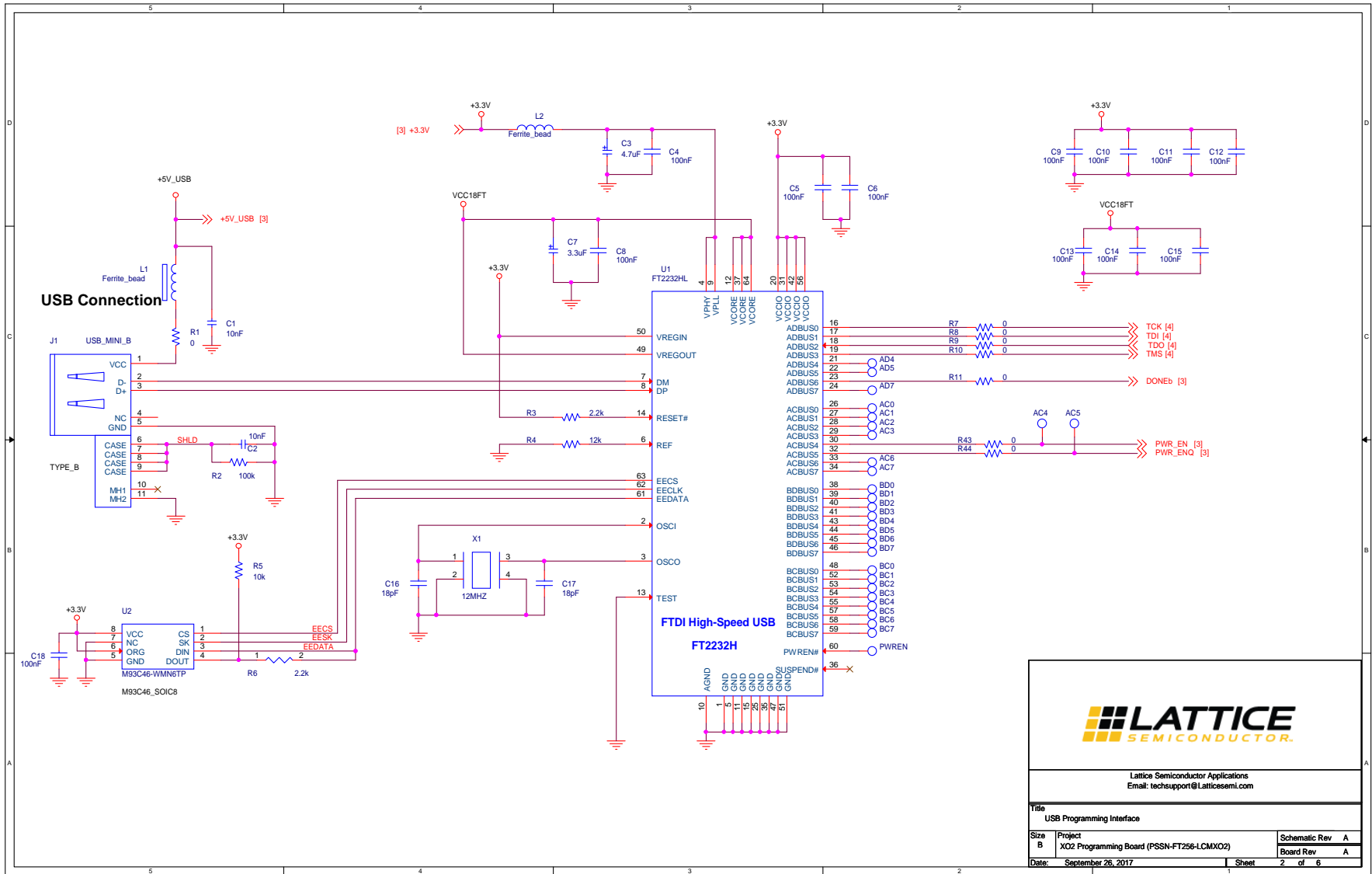

Figure A.1. USB Programming Interface

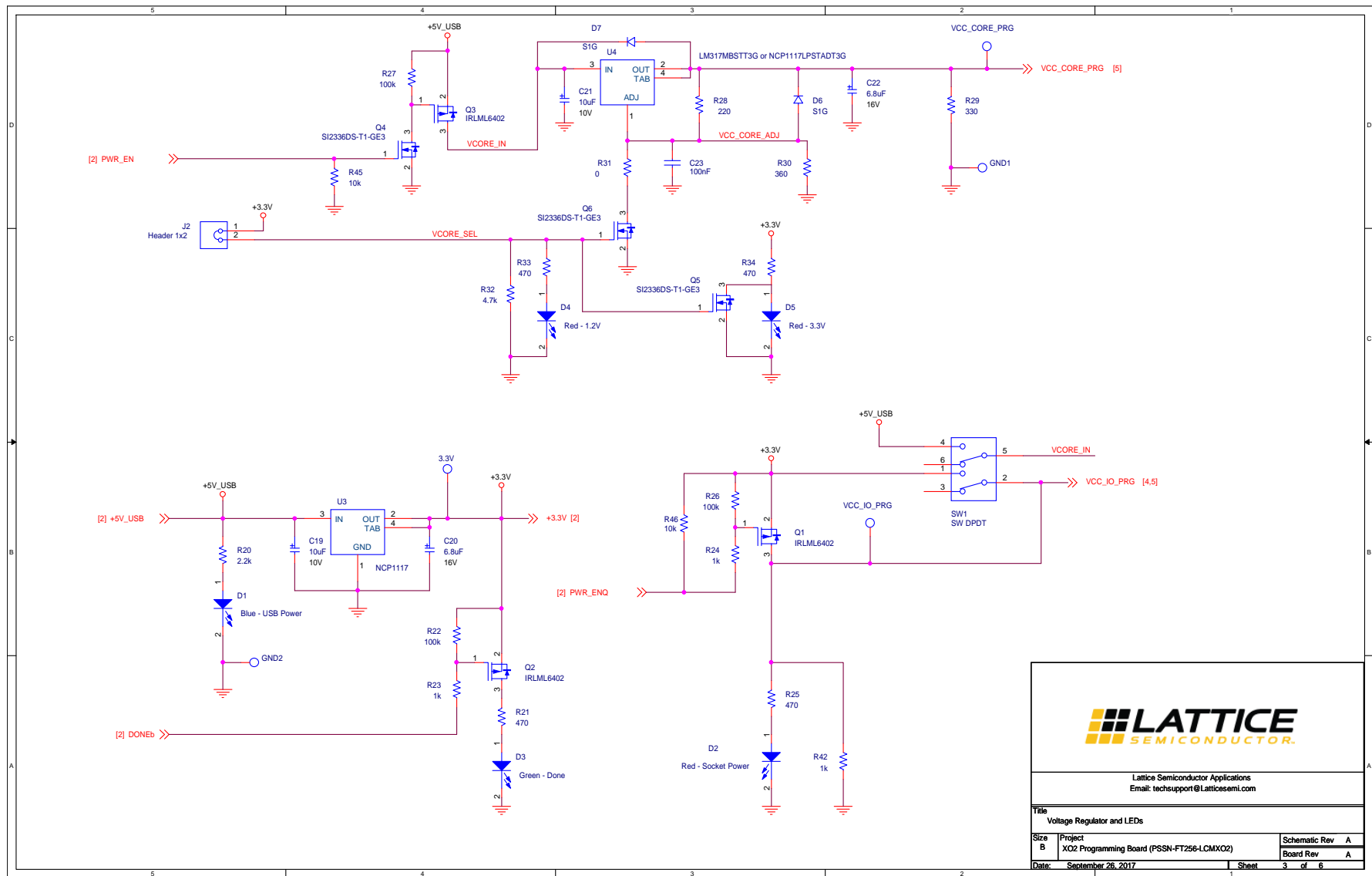

Figure A.2. Voltage Regulator and LEDs

Lattice Semiconductor Applications  
Email: techsupport@Latticesemi.com

Title		Voltage Regulator and LEDs	
Size	Project	Schematic Rev	A
B	XO2 Programming Board (PSSN-FT256-LCMXO2)	Board Rev	A
Date:	September 26, 2017	Sheet	3 of 6



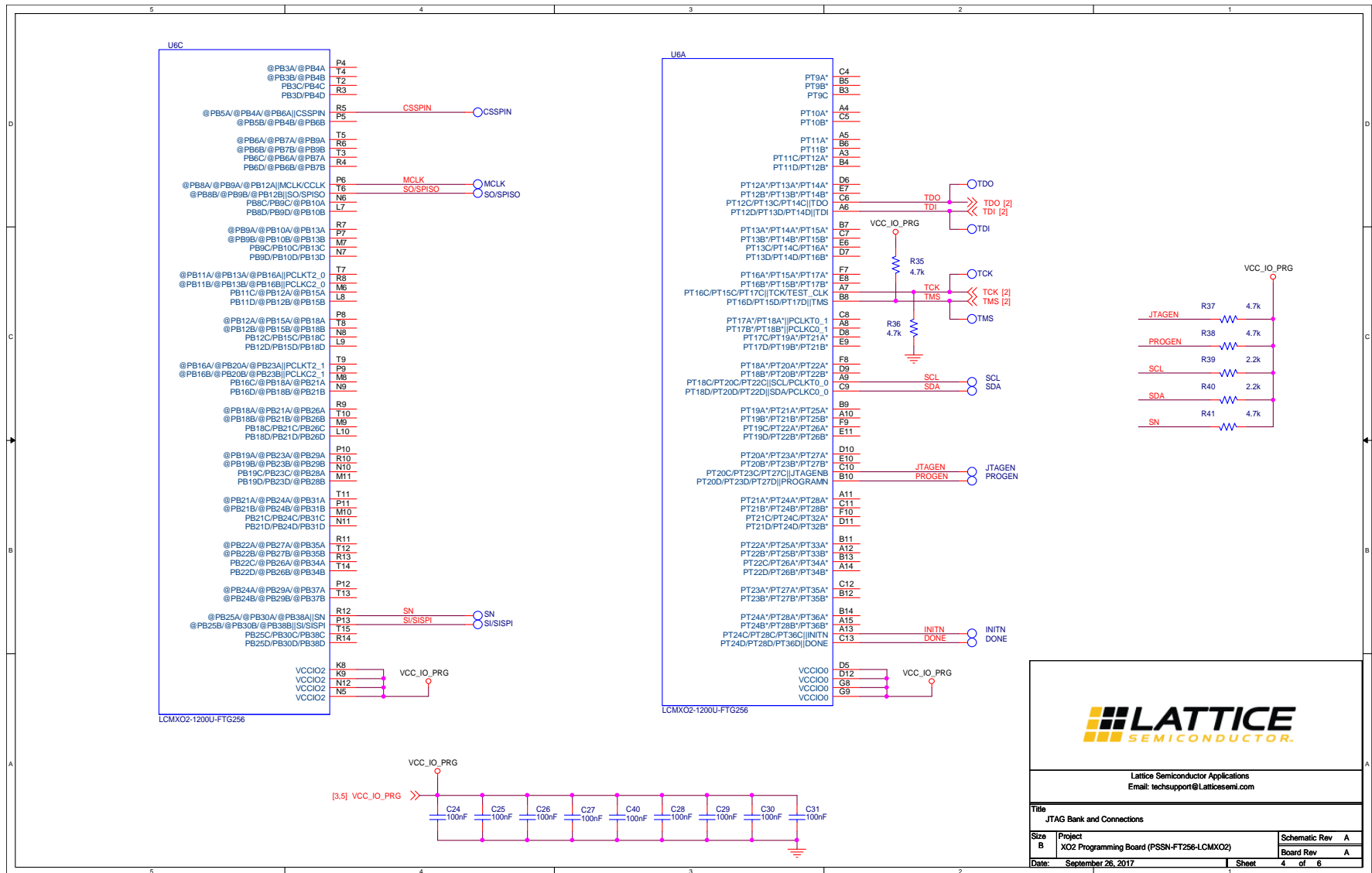

Figure A.3. JTAG Bank and Connections

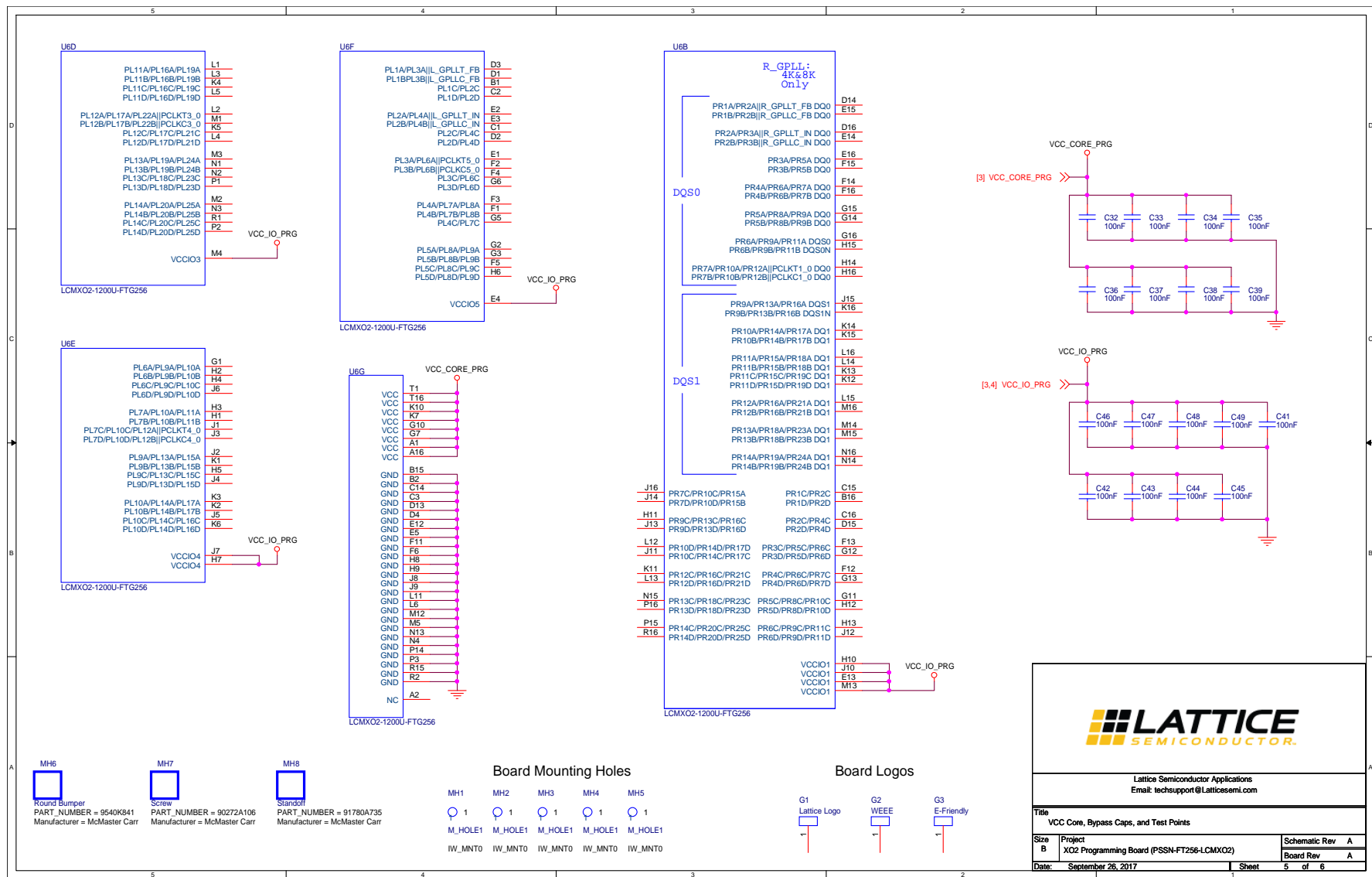

Figure A.4. VCC Core, Bypass Caps, and Test Points

## Appendix B. Debugging

Check the following if the programming fails:

- USB power supply
- ON/OFF switch is turned ON to provide power to the socket
- Device scanning failed

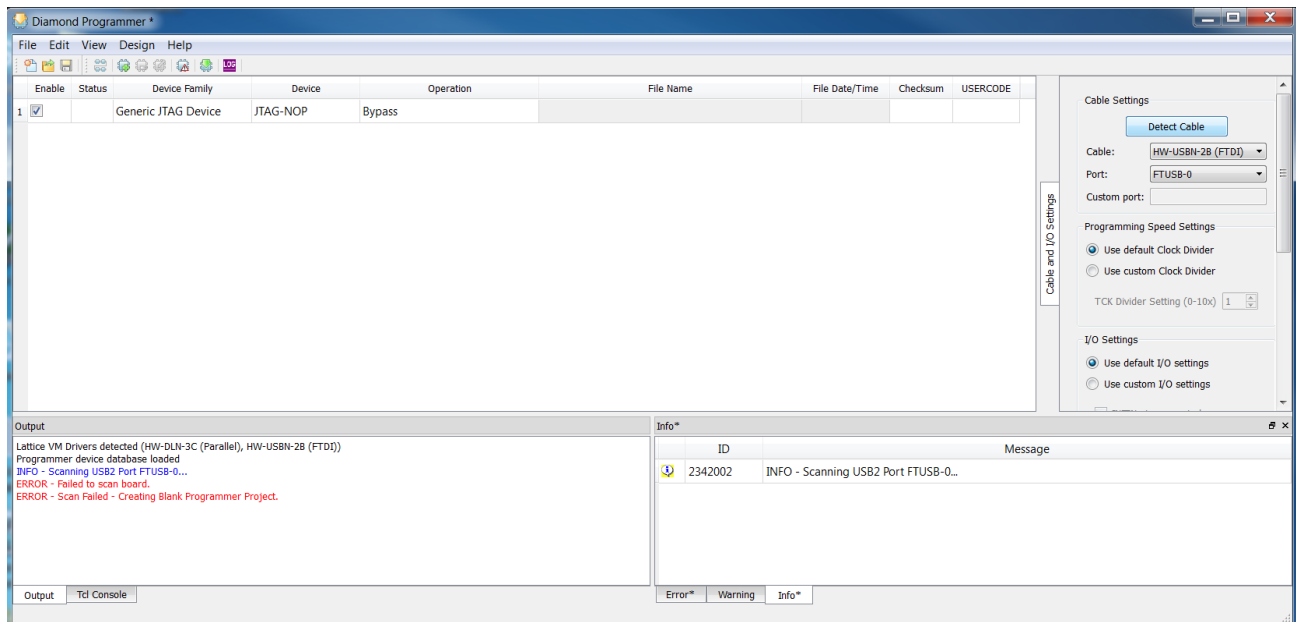

Figure B.1. Failed to Scan Device

Click the **Detect Cable** button and the Diamond Programmer starts detecting all the cables attached to USB ports. In the **Cable** dropdown menu, select the option which has the FTDI as shown in the figure below.

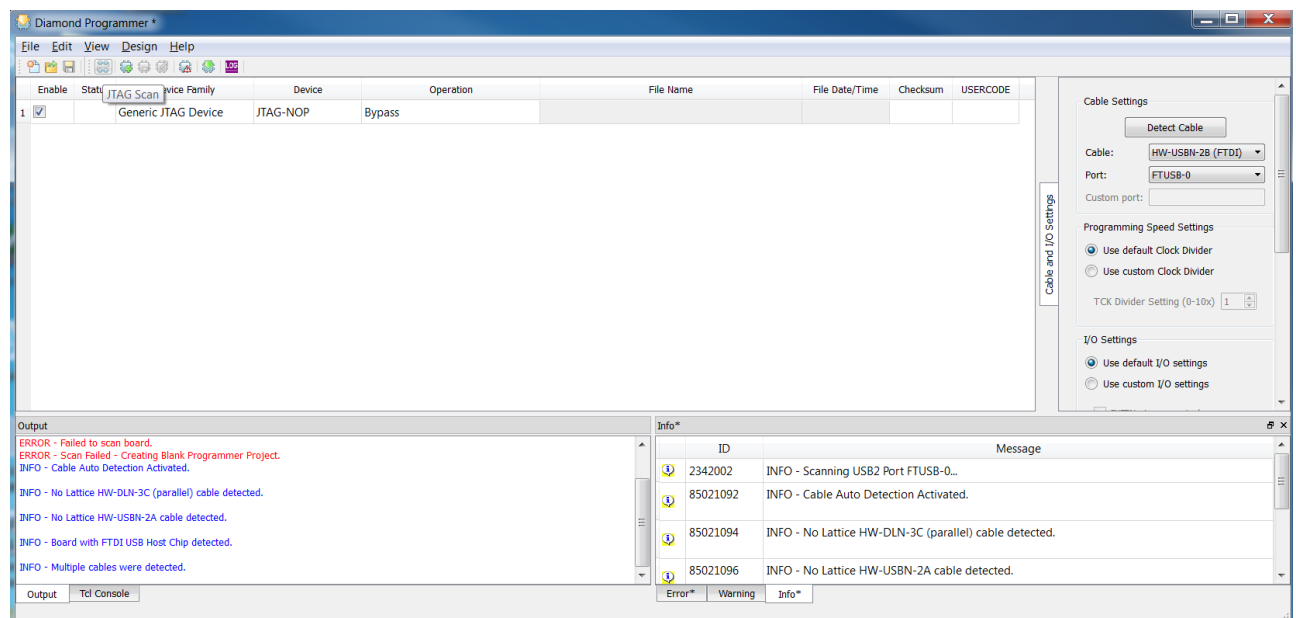
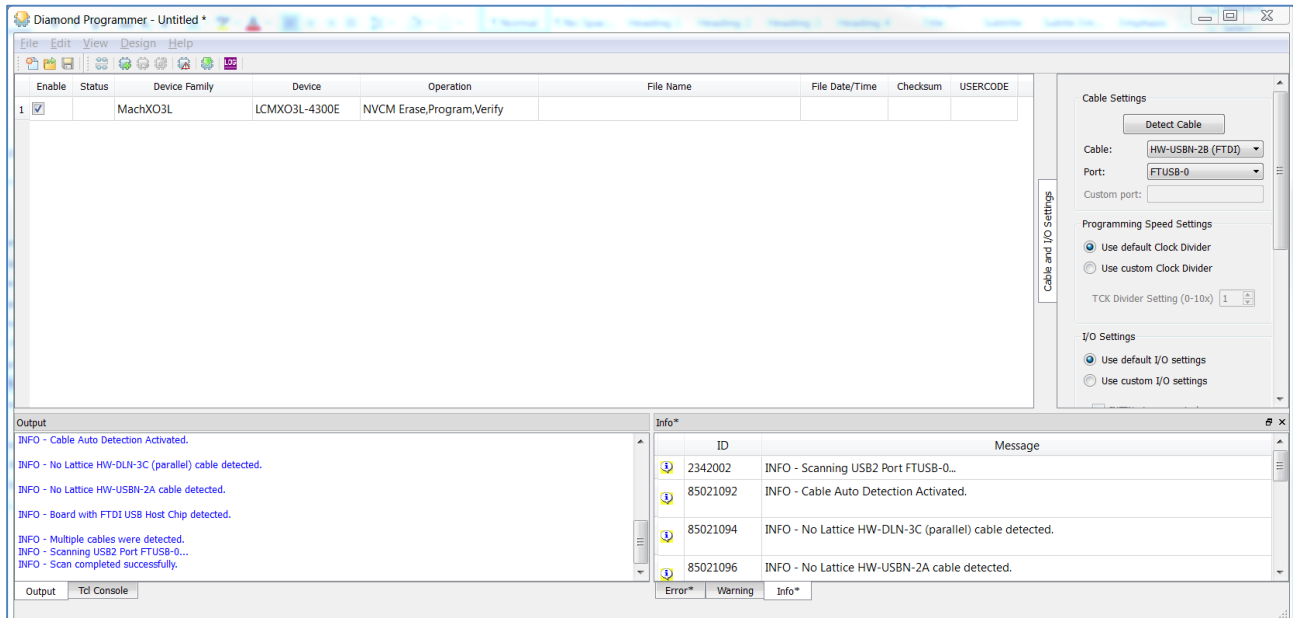

Figure B.2. Detect Cable (FTDI)

Ensure that the ON/OFF switch is turned to the ON position. The Diamond Programmer starts scanning the device in the socket. When the scan is completed, the exact device present in the socket appears in the **Device** tab as shown in [Figure B.3](#).



**Figure B.3. Scanning Completed**

## Revision History

Date	Version	Change Summary
April 2018	1.1	Changed document number from UG114 to FPGA-UG-02046.
		Change document status from Preliminary to final.
		Removed copyright page.
		Added <a href="#">Appendix A. Smart Socket Board Schematics</a> section.
		Applied minor editorial and formatting changes.
February 2016	1.0	Initial release.



7<sup>th</sup> Floor, 111 SW 5<sup>th</sup> Avenue  
Portland, OR 97204, USA  
T 503.268.8000  
[www.latticesemi.com](http://www.latticesemi.com)