

Panasonic

Panasonic

HJ4-L-DC24V-D-6

Artikelnummer: HJ4-L-DC24V-D-6

Tillverkare / Brand: Panasonic

Produktbeskrivning: HJ 4FORM C DC 24V

Datablad:

RoHS status

 Blyfri / Överensstämmer med RoHS

Lager skick

9249 pcs stock

Skicka från

Hong Kong

Leveransväg

DHL/Fedex/TNT/UPS/EMS

OFFERTFÖRFRÅGAN

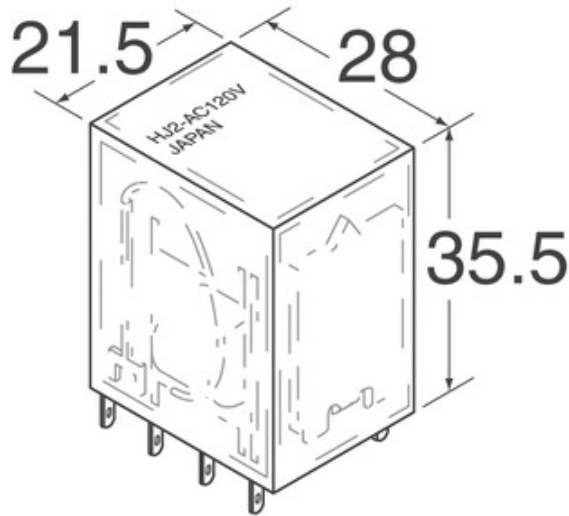

Bilden kan vara representation. Se specifikationer för produktinformation.













Specifikationer för HJ4-L-DC24V-D-6

ARTIKELNUMMER	HJ4-L-DC24V-D-6
TILLVERKARE	Panasonic
BESKRIVNING	HJ 4FORM C DC 24V
LEDNINGSFRI STATUS / ROHS-STATUS	Blyfri / Överensstämmer med RoHS
TILLGÄNGLIG KVANTITET	9249 pcs
DATABLAD	
SERIER	*
FUKTKÄNSLIGHETSNIVÅ (MSL)	1 (Unlimited)
LEDNINGSFRI STATUS / ROHS-STATUS	Lead free / RoHS Compliant
DETALJERAD BESKRIVNING	Relay Coil

Relaterade etiketter

Panasonic HJ4-L-DC24V-D-6	HJ4-L-DC24V-D-6-distributör	HJ4-L-DC24V-D-6 Leverantör
HJ4-L-DC24V-D-6 pris	HJ4-L-DC24V-D-6 Bilder	HJ4-L-DC24V-D-6-bild
HJ4-L-DC24V-D-6 PDF Datablad	HJ4-L-DC24V-D-6 Ladda ner datablad	HJ4-L-DC24V-D-6 datablad
HJ4-L-DC24V-D-6-lager	Köp HJ4-L-DC24V-D-6	Köp Panasonic HJ4-L-DC24V-D-6
Panasonic HJ4-L-DC24V-D-6	Panasonic Leverantör	Panasonic-distributör
Panasonic HJ4-L-DC24V-D-6	Panasonic - Consumer Division HJ4-L-DC24V-D-6	Panasonic - Consumer Electronics Corp. HJ4-L-DC24V-D-6
Panasonic Battery Group HJ4-L-DC24V-D-6	Panasonic Electric Works - ACSD HJ4-L-DC24V-D-6	Panasonic Electronic Components - Semiconductor Pr HJ4-L-DC24V-D-6
Panasonic - ATG HJ4-L-DC24V-D-6	Panasonic - BSG HJ4-L-DC24V-D-6	Panasonic - DTG HJ4-L-DC24V-D-6
Panasonic Electric Works HJ4-L-DC24V-D-6	Panasonic Electronic Components HJ4-L-DC24V-D-6	Panasonic Industrial Automation Sales HJ4-L-DC24V-D-6
Panasonic Semiconductor HJ4-L-DC24V-D-6		

Relaterade produkter

 <p>HJ4-L-DC48V-6 tillverkare: Panasonic Beskrivning: RELAY GENERAL PURPOSE I lager: 6054 pcs</p> <p>RFQ</p>	 <p>HJ4-L-DC12V-6 tillverkare: Panasonic Beskrivning: RELAY GENERAL PURPOSE I lager: 5283 pcs</p> <p>RFQ</p>
 <p>HJ4-L-DC24V-D tillverkare: Panasonic Beskrivning: RELAY GENERAL PURPOSE I lager: 6763 pcs</p> <p>RFQ</p>	 <p>HJ4-L-DC24V tillverkare: Panasonic Beskrivning: RELAY GEN PURPOSE 4PDT 5A 24V I lager: 10307 pcs</p> <p>RFQ</p>
 <p>HJ4-L-DC48V-D-6 tillverkare: Panasonic Beskrivning: RELAY GENERAL PURPOSE I lager: 6998 pcs</p> <p>RFQ</p>	 <p>HJ4-L-DC48V-D tillverkare: Panasonic Beskrivning: RELAY GENERAL PURPOSE I lager: 4072 pcs</p> <p>RFQ</p>
 <p>HJ4-L-DC48V tillverkare: Panasonic Beskrivning: RELAY GEN PURPOSE 4PDT 5A 48V I lager: 11557 pcs</p> <p>RFQ</p>	 <p>HJ4-L-DC12V-D tillverkare: Panasonic Beskrivning: RELAY GENERAL PURPOSE I lager: 3044 pcs</p> <p>RFQ</p>
 <p>HJ4-L-DC12V-D-6 tillverkare: Panasonic Beskrivning: RELAY GENERAL PURPOSE I lager: 3953 pcs</p> <p>RFQ</p>	 <p>HJ4-L-DC24V-6 tillverkare: Panasonic Beskrivning: RELAY GENERAL PURPOSE I lager: 3786 pcs</p> <p>RFQ</p>
 <p>HJ4-L-T-AC120V tillverkare: Panasonic Beskrivning: RELAY GEN PURPOSE 4PDT 5A 120V I lager: 9348 pcs</p> <p>RFQ</p>	 <p>HJ4-L-T-AC100V tillverkare: Panasonic Beskrivning: RELAY GEN PURPOSE 4PDT 5A 100V I lager: 8903 pcs</p> <p>RFQ</p>

Copyright © 2020 Tillförlitlig distributör av elektroniska komponenter

E-post: Info@infinity-electronic.com

Adress: 17F, Gaylord Commercial Building, 114-118 Lockhart Road, Wan Chai, Hong Kong

